

PROTECTION SYSTEMS

1st Edition

Table of Contents

Technical Reference

Overview

Protection systems in the communications network.....	4
Applications of overvoltage protection.....	4
Different forms of overvoltage.....	4
Recommendations for the application of protection measures.....	5
Costs and benefits for the user	5
Operating conditions.....	6
Operating conditions.....	7
Selection.....	7
Operating voltage/technical data.....	8
Fail-safe.....	8
Choosing protection components.....	9
Magazines for LSA-PLUS and LSA PROFIL Systems	11
Technical specifications	12

ComProtectOvervoltage Protection

LSA-PLUS and LSA PROFIL Modules

Basic Protection Magazine for LSA-PLUS Series 2 Blocks	14
3-Pole Overvoltage Arrestors	16
2-Pole Overvoltage Arrestors	16
Magazine Cover.....	17
Basic Protection Plugs for LSA-PLUS Series 2 Blocks.....	18
Intermediate Protection Plugs for LSA-PLUS Series 2 Blocks.....	19
Data Protection Plug for LSA-PLUS Series 2 Blocks	20
Current Protection Plug for LSA-PLUS Series 2 Blocks	21
Overvoltage Protection Components and Diodes for Secondary Protection.....	22
Maintenance-Free Protection Plug for LSA-PLUS Series 2 Blocks	23
Earth Plug for LSA-PLUS Series 2 Blocks.....	24
Earth Bars for LSA-PLUS Modules	25

Mini-distributors

Test Device for Protection Components	26
---	----

Protection systems in the communications network

The importance of overvoltage protection has increased considerably over the past years. On one hand, this is due to growing demands placed on advanced communications systems that increasingly support voice, video and data transmissions. On the other, the deployment of electronics further into the network has resulted in miniaturization – with an increased integration density – and hence reduced electrical strength.

Connection and distribution technologies from TE Connectivity set a global standard and are supplemented by a powerful and flexible portfolio of protection solutions. Individual protection possibilities enable an optimum cost-to-benefit ratio and ensure maximum economic efficiency for the user.

Applications of overvoltage protection

Protection systems are used wherever communication lines are distributed and connected. Overvoltage protection fulfils various requirements, depending on the type of installation to be protected. In conventional switching equipment, overvoltage protection is used primarily to protect people. In highly sensitive electronic switching equipment installations, however, comprehensive protection measures are necessary in order to protect not just people, but also the valuable installation itself.

Overvoltage is undoubtedly the primary cause of faults, i.e. interference caused by electrical energy disturbances in communication lines. The term “overvoltage” often calls to mind thunderstorms releasing vast amounts of energy. However, even static discharges, which may appear to be harmless, can seriously affect signal transmission or even paralyse entire networks. Overvoltage in supply lines for centrally controlled process management and control systems can sometimes lead to immense damage and costs into the millions, or even to irrecoverable losses.

Different forms of overvoltage

Although the different forms of overvoltage have basically remained unchanged for many years, their causes and effects are subject to change. Overvoltage can be caused not only by reproducible interferences, but also by impulses that occur randomly. Reproducible excess voltages caused, for example, by capacitive or inductive switching, are often easy to localize and suppress. In order to achieve efficient protection against excess voltages caused by non-reproducible interferences, a range of standards and recommendations can be adopted with a view to causes, duration and injection of such interferences into the system. Overvoltage in communication networks is usually the result of electromagnetic interference, equalizing currents between different earth potentials or network short circuits. This is caused by switching operations on neighboring lines, the indirect effect of lightning or natural forces, or by human error. The direct effect of lightning on distribution equipment is an exception, because this type of equipment is usually installed indoors or in enclosures. The massive amount of energy involved in direct lightning strikes requires separate protection concepts and structural measures.

Apart from direct lightning strikes, however, interference by one of the following phenomena is more often than not the cause of damage to or destruction of communication systems:

- Indirect lightning impact
- Electromagnetic interference
- Inductive or capacitive effects
- Electrostatic discharge
- Contact with live power lines
- These conditions often represent a high degree of danger to human life.

Recommendations for the application of protection measures

Overvoltage protection devices consist of components or protective circuits that limit interference to permissible values. Overvoltage protection devices must adapt to regional and local requirements. These requirements include operating conditions on the line and the protection requirements that result from the specific application area.

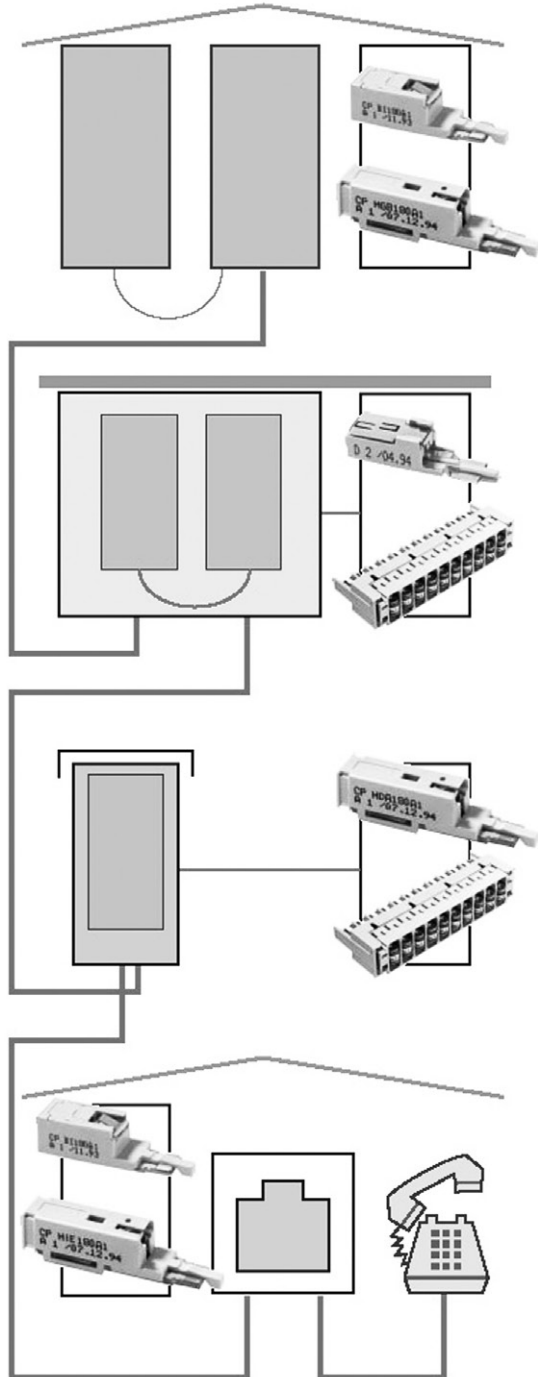

Graded protective circuits with secondary protection elements should be used for incoming circuits on the exchange side and for terminal equipment (telephone, fax, modem), because in addition to personnel safety, sensitive electronic systems must also be protected. High voltage protection is usually sufficient for the line. In the event that active components are installed in a cross-connection cabinet, graded protective circuits are also recommended.

Costs and benefits for the user

When selecting suitable overvoltage protection modules, the cost-to-benefit ratio is of interest. The cost of installing protection modules contrasts favorably to the increased availability of the communication network and lower repair costs. An optimum selection on the part of the network operator results in minimum costs with maximum economic efficiency of the equipment. The extent of protection measures is based on the requirements and specifications from the network operator or the equipment manufacturer. In the idealized diagram shown here, the cost minimum is the point where the two curves meet.

In order to protect personnel, applicable standards and regulations for setting up and operating telecommunications networks must also be observed.

Cost relationships

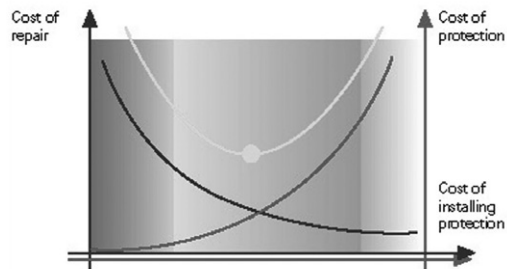

The applicable standards and/or regulations for setting up and operating telecommunication networks must also be observed to protect personnel

Operating conditions

TE Connectivity's range of protection system products is designed to meet the needs of our copper-based connection and distribution systems. In most applications, the protection modules are electrically equivalent; however, they are not necessarily compatible in their contact and protection behavior.

Basic differentiators include:

- Operating behavior of the system to be protected
- Overvoltage protection requirements (electrical and mechanical) e.g., requirements facing the permissible impulse current or the permissible AC discharge current. The network operator's specifications must be observed when designing the protection modules.
- The LSA-PLUS[®], LSA PROFIL[®] or MDF 71 connection system used
- Requirements for protection for a single pair, or an entire module

Furthermore, protection equipment and systems must be designed to meet the needs of the following network conditions.

Before the planning phase begins, the requirements for the protection system must be examined together with the operating conditions. An over-designed protection system rarely leads to damage. However, it does impact the economic efficiency of the equipment. Over-designed protection also means an increase in repair costs and poses a personnel risk.

Installation takes place after the distribution equipment has been set up. Retrofitting existing equipment is, in most cases, not a problem if LSA-PLUS[®] and LSA PROFIL[®] systems are installed.

Network condition	Selection condition	Protection module
Operating voltage	<	Response voltage
Voltage resistance of the equipment to be protected	>	Impulse response voltage
Operating current	<	Nominal current
Bandwidth	<	Cut-off frequency

Aside from the electrical characteristics, the conditions of the interface with the distributor system and, if necessary, the housing dimensions must be taken into consideration at the earliest possible stage. The following protection modules are available for the LSA-PLUS[®] Series 2 blocks.

Protection Modules	LSA-PLUS [®] Distribution Blocks	Jumpering with protection element in place
Magazines	Connection or disconnection	no
1-pair ComProtect B series	Disconnection or switching	yes
1-pair ComProtect H series	Disconnection or switching	yes

Technical Reference

Overview

Operating conditions

Distribution modules with disconnection, switching and connection contacts can be used with TE Connectivity protection components. Disconnection and switching modules permit the insertion of serial protection components into circuits; connection modules only permit parallel contact access.

Selection

Regardless of the series and circuit used, overvoltage protection components are all based on the same working principle: any excessive voltages are discharged to earth. Depending on the component, the energy consumption in the protection device is relatively small. One precondition for this is the protection component's low-resistance earthing.

In line with signal potentials, a distinction is made between three-point and five-point protection. For connection modules, only three-point protection is possible. Five-point protection (components in the signal path) is recommended for use with switching modules. Once the protective plug is removed, the contact in the module is open and possible faults cannot make their way to the downstream network. Five-point protection can also be implemented using disconnection modules.

TE Connectivity supplies various protective circuits:

- Three-point protection: pure overvoltage protection (high-voltage or secondary protection)
- Five-point protection: overvoltage protection combined with current protection
- Five-point protection: graded protection (high-voltage and secondary protection with current protection)

Components designed for single-pair protection provide a safe and reliable solution in LSA-PLUS and LSA PROFIL distribution systems and have advantages over multiple-pair protection magazines for eight- and/or ten-pair modules. When a single-pair protection plug has to be removed, this does not mean that the entire module (all eight or ten pairs) is then left unprotected. Partial or combined equipping of the modules is also possible. Because of their small dimensions, the most convenient protection plugs (ComProtect HDA, B and H series) also offer the option of switching and jumpering with protection components in place. All protection functions thus remain guaranteed at all times for both the communication equipment and maintenance personnel.

The advantages of protection magazines for eight and ten pairs are mainly based on the fast set up and lower installation costs of a protection panel. When necessary, protection magazines for LSA-PLUS and LSA PROFIL can be installed in the distributor in combination with ComProtect components

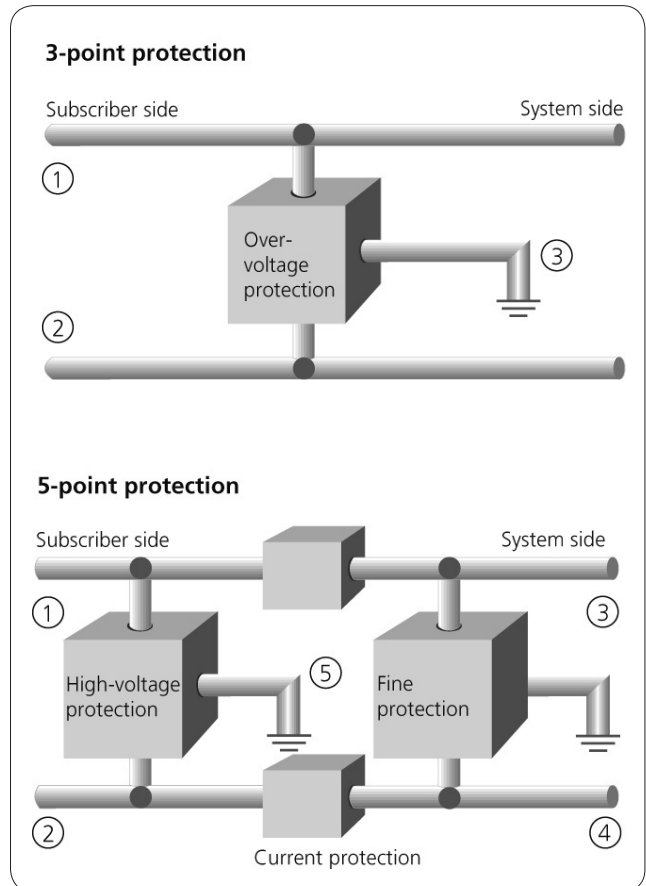
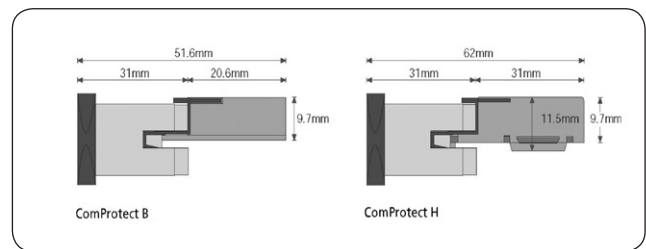

Technical Reference

Overview

Operating voltage/technical data

The operating voltage of the system to be protected determines the protection plug's voltage class. The protection device must not be triggered during normal operation. This would not only destroy the protective circuit, it would also lead to interruption in signal transmission. The highest possible voltage class should be selected for the protection plug – at least above the maximum voltage possible during operation (maximum operating voltage, including tolerance). The upper limit for selecting the protection plug's voltage class is determined by the maximum protection level permitted, i.e., the maximum input voltage that would not damage the downstream system components should overvoltage occur. The selection of components and switching configurations determines other electrical parameters for protective circuits.

Properly designed and specified overvoltage protection components have a serviceable life of several decades and require no additional maintenance. TE Connectivity recommends that the nominal DC spark-over voltage of installed protection components be tested regularly. For safety reasons, the arrestors should be replaced if the protective circuit has been subjected to impulse current.

Fail-safe

Protective circuits with an integrated fail-safe feature are highly recommended. Components for overvoltage protection are usually designed only for pulse-shaped loads. Therefore, if permanent overloads are possible (e.g., mains contact), a safe short-circuit to earth must be ensured. Overloaded or overheated protection components would not only lose their protection function, they could cause fire or an explosion, leading to considerable damage and expense.

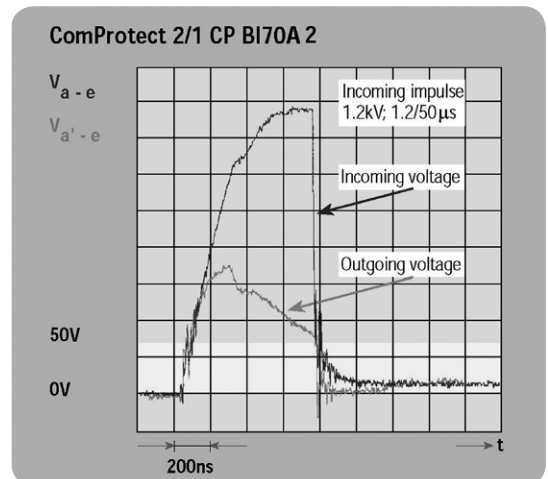
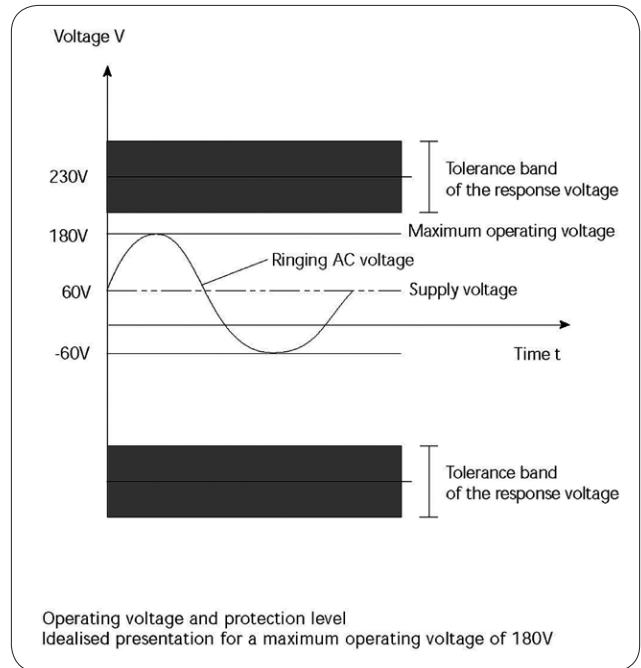

Choosing protection components

The mechanical interface where the protection components is going to be installed has to be taken into account. TE Connectivity offers a large number of complete magazine solutions and flexible single-pair protection plugs. Our product portfolio offers various levels of protection with extended features that have a direct influence on the severity of the network downtime and the associated commercial loss.

The TE Connectivity portfolio includes a broad range of performance classes:

- Basic protection plugs
- Intermediate protection plugs
- Advanced protection plugs
- Maintenance-free advanced protection plugs

Given the number and variety of applications and new transmission modes employed in communications networks, please refer to the tables on pages 8 and 9 for a detailed overview of the available protection components in association with transmission rates and other network features as a basis for choosing the protection type best suited to your application.

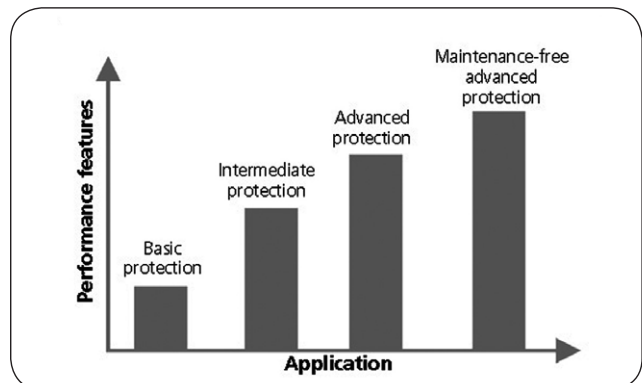
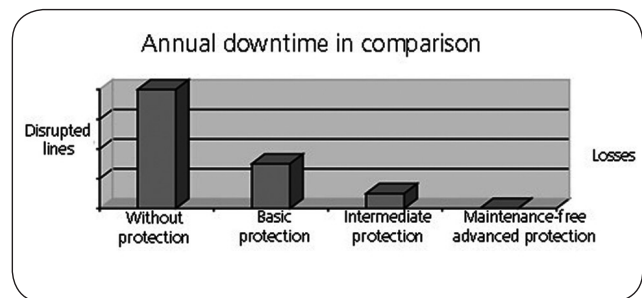

Recommended applications	Telecommunication										Data		Number of protected pairs		
	Analog Lines	ISDN S ₀ -interface	ISDN S2M-interface	PMXA primary multiplexer connection	PCM (without remote power feeding)	PCM (with remote power feeding)	PCM11 (with sym. remote power feeding)	Modem for telephone line	Modem for Datex P	ADSL transmission	RS 232	RS 485		Ethernet (CAT5)	
Operating voltage	160 V	42 V	100 V	60 V	5 V	100 V	320 V	60 V	12 V	160 V	12 V	12 V	5 V	Inverted circuit configuration for installation in distributor block on the system side, since the disturbance is expected from the jumper side	
Operating current	< 100mA	< 60 mA	< 120 mA	< 60 mA	< 60 mA	< 60 mA	< 60 mA	< 60 mA	< 60 mA	< 120 mA	< 20 mA	< 20 mA	< 20 mA		
Transmission rate	4 kHz	192 kbit/s	2 Mbit/s	2 Mbit/s	2 Mbit/s	2 Mbit/s	2 Mbit/s	64 kbit/s	48 kbit/s	8 Mbit/s	20 kbit/s	2 Mbit/s	100 Mbit/s		
ComProtect	Cat. number	For LSA-PLUS and LSA PROFIL modules													
Magazine 2/10	6089 2 023-08	x													10
CP HGB180A1	5909 1 063-40	x	x		x		x								1
CP HDA180A1	5909 1 064-00	x													1
CP HVG180A6	5909 1 063-30	x	x		x		x							x	1
CP HIE5A1	5909 1 120-00												x		1
CP BI180A1	5909 1 076-00	x		x			x				x				1
CP BOD180A4	5909 1 078-30	x		x			x				x				1
CP BOD270A1	5909 1 086-00							x							1
CP BI70A2	5909 1 082-01		x		x				x						1
CP BI24A1	5909 1 083-00														1
CP BI12A1	5909 1 084-00					x				x		x			1

ORDERING INFORMATION

Description	Catalog Number
Protection Magazine for HD180, 10-pair modules	
Surge voltage protection magazine	
180 V, 10 pairs with 3-pole arrestors and fail-safe	PRO-7019 2 220-00
330 V, 10-pairs with 3-pole arrestors without fail-safe	PRO-7109 2 220-20

Technical Reference

Overview

Magazines for LSA-PLUS and LSA PROFIL Systems

TE Connectivity's product portfolio includes various magazines for overvoltage protection. Typical three-point protection is implemented in the magazines; the protective components are connected to a common central connection (earth potential) when installed in the magazine. Overvoltage arrestors serve as protective components. They offer high energy absorption and very low capacitance values. In special cases, magazines can also be fitted with polycrystalline overvoltage protection components. Magazines can be particularly improved by installing fail-safe contacts in addition to the overvoltage arrestors.

In the case of magazines for overvoltage protection in the LSA-PLUS distribution system, fail-safe contacts (thermal protection springs) can be simply plugged in, hence connecting them parallel to the two-electrode arrestors, or are just integrated onto the three-pole arrestors. If the arrestor overheats as a result of overvoltage, a solder material melts, triggering the fail-safe function to generate a short-circuit to earth parallel to the arrestors, hence discharging any subsequent currents.

TECHNICAL SPECIFICATIONS

The following technical specifications and dimensions of the ComProtect products have been compiled for the standard offering of one-pair protection components.

Transmission behavior	ComProtect B Series	ComProtect H Series
Jumpering ability	+(+)	+(+)
Line protection	++	++
Reversible current protection	++	++
Partial/ combined fitting	++	++
Fail-safe	++	++
Secondary protection	++	
High voltage protection	++	++

++ = Very good

+(+) = Good (or optional very good)

Technical Data

ComProtect / types		Type B					
Technical specifications	2/1CP...	BI12A1	BI24A1	BI70A2	BI180A1	BOD180A4	Unit
Max. operating voltage (a–b, b–b')	V_{max}	12	24	70	180	180	V DC
Nominal response DC voltage (over-voltage arrestors *)	V_{ag}	90	90	90	230	350	V
Tolerance of the nominal response DC voltage		± 20	± 20	± 20	± 20	± 20	%
Max. nominal current at 20°C	I_N	90	90	90	120	120	mA
Max. output voltage at 1kV/μs	V_o	30	60	190	350	350	V
Nominal discharge impulse current (B/20μs), (a/b–e) *)	I_{IN}	5	5	5	5	5	kA
Nominal AC discharge current (a/b–e) *)	I_{wN}	–	–	5	5	5	A_{rms}
Nominal decoupling resistance at 20°C	R	25	25	25	10	10	Ω
Typical switching time for current protection (500mA/25°C)	t_t	≤ 3	≤ 3	≤ 3	≤ 10	≤ 3	s
Response time, Fail-safe @ 1A	t_f	≤ 10	≤ 10	≤ 10	≤ 10	≤ 10	s
Response time, Fail-safe @ 5A	t_f	< 5	< 5	< 5	< 5	≤ 5	s
Insulation resistance (without secondary protection) at 100V	R_{isol}	–	–	–	1000	1000	MΩ
Leakage current (secondary protection / with voltage)	I_L	≤ 1	≤ 1	≤ 10	≤ 5	≤ 5	μA
Nominal capacity at 1MHz/1V _{rms} (a/b–e)	C	100	50	50	50	50	pF
Typical cut-off frequency (–3dB, $Z_w = 600\Omega$)	f_g	8	8	8	8	8	MHz
Typical cut-off frequency (–3dB, $Z_w = 150\Omega$)	f_g	30	30	30	30	30	MHz
Impulse voltage resistance (1,2/50μs), 3 x	U_{sp}	1.75	1.75	1.75	1.75	1.75	kV
AC voltage resistance (50Hz), 1 min	U_{sw}	1000	1000	1000	1000	1000	V _{rms}
Operating temperature:		–20°C ... +60°C					
Storage temperature:		–40°C ... +80°C					
Electrical testing:		*) According to ITU K. 12					
Mechanical loads:		Sinusoidal-shaped oscillations according to IEC 68-2-6					
Climatic conditions:		DIN IEC 68 part 2–2/3 (exposure to high temperatures) DIN IEC 68 part 2–1 (exposure to low temperatures)					

Technical Data

ComProtect / types		Type H					
Technical specifications	2/1CP...	HEB180A1	HDA180A1	HGB180A1	HGB180A2	HIE05A1	Unit
Max. operating voltage (a–b, b–b')	V_{max}	180				5	V DC
Nominal response DC voltage (over-voltage arrestors *)	V_{ag}	230		230	230	230	V
Tolerance of the nominal response DC voltage		± 20		± 20	± 20	± 20	%
Max. nominal current at 20°C	I_N	110	–	120	120	120	mA
Max. output voltage at 1kV/μs	V_o	< 700		< 500	18	35	V
Nominal discharge impulse current (B/20μs), (a/b–e) *)	I_{IN}	3		5	5	5	kA
Nominal AC discharge current (a/b–e) *)	I_{wN}	3		5	5	5	A_{rms}
Nominal decoupling resistance at 20°C	R	1	–	8	8	8	Ω
Typical switching time for current protection (500mA/25°C)	t_t	5	–	6	6	6	s
Response time, fail-safe @ 1A	t_f	< 25		< 25	≤ 10	≤ 10	s
Response time, fail-safe @ 5A	t_f	< 10		< 10	≤ 10	≤ 10	s
Insulation resistance (without secondary protection) at 100V	R_{isol}	> 1000		> 1000	–	–	MΩ
Leakage current (secondary protection)/ with voltage	I_L	–		–	< 1 / 5	< 1 / 12	μA
Nominal capacity at 1MHz/1V _{rms} (a/b–e)	C	< 5		< 5	< 15	< 15	pF
Typical cut-off frequency (–3dB, $Z_w = 600\Omega$)	f_g	> 65		> 65			MHz
Typical cut-off frequency (–3dB, $Z_w = 150\Omega$)	f_g	> 100		> 100			MHz
Operating temperature:		–20°C ... +60°C					
Storage temperature:		–40°C ... +80°C					
Electrical testing:		*) According to ITU K. 12					
Mechanical loads:		Sinusoidal-shaped oscillations according to IEC 68-2-6					
Climatic conditions:		DIN IEC 68 part 2–2/3 (exposure to high temperatures) DIN IEC 68 part 2–1 (exposure to low temperatures)					

ComProtect Overvoltage Protection

ComProtect Overvoltage Protection

LSA-PLUS and LSA PROFIL Modules

Basic Protection Magazine for LSA-PLUS Series 2 Blocks	14
3-Pole Overvoltage Arrestors	16
2-Pole Overvoltage Arrestors	16
Magazine Cover.....	17
Basic Protection Plugs for LSA-PLUS Series 2 Blocks	18
Intermediate Protection Plugs for LSA-PLUS Series 2 Blocks	19
Data Protection Plug for LSA-PLUS Series 2 Blocks	20
Current Protection Plug for LSA-PLUS Series 2 Blocks	21
Overvoltage Protection Components and Diodes for Secondary Protection.....	22
Maintenance-Free Protection Plug for LSA-PLUS Series 2 Blocks	23
Earth Plug for LSA-PLUS Series 2 Blocks.....	24
Earth Bars for LSA-PLUS Modules	25

Mini-distributors

Test Device for Protection Components	26
---	----

ComProtect Overtoltage Protection

LSA-PLUS and LSA PROFIL Modules

Basic Protection Magazine for LSA-PLUS Series 2 Blocks

This basic protection magazine is recommended for use as a basic overvoltage protection in analog and digital telecommunication systems. The magazines are designed for the complete equipping of LSA-PLUS or LSA PROFIL disconnection or connection modules. For installation in LSA PROFIL distributors, earth contact clips are required to establish earth contact with the profile rods.

Optimal function for magazines is guaranteed only when used in conjunction with the corresponding overvoltage arrestors.

FEATURES

- Designed for use with 2- or 3-pole overvoltage arrestors
- Overvoltage arrestors and fail-safe elements are replaceable
- Installation height is approximately 25 mm above the LSA-PLUS or LSA PROFIL module

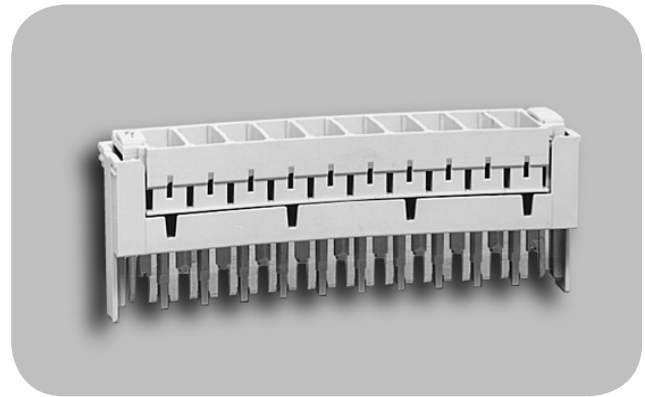

Magazine 2/10 for 3-pole gas discharge tubes (GDT)

Ordering information appears on the following page.

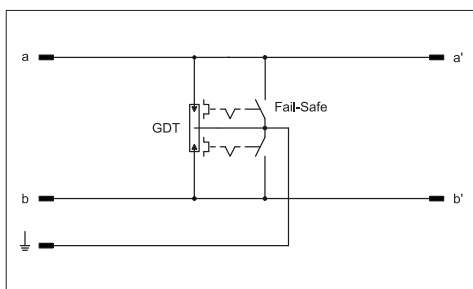

6089 2 023-08, 6036 2 003-04

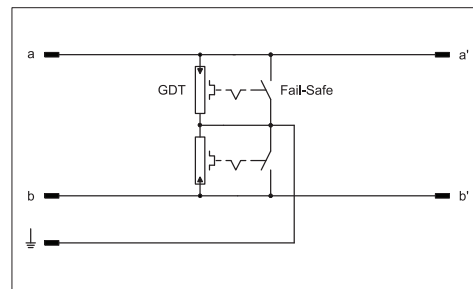

6089 2 024-61, 6036 2 004-61

ComProtect Overvoltage Protection

LSA-PLUS and LSA PROFIL Modules

ORDERING INFORMATION

Description	Weight/Pack	Catalog Number
Basic protection magazine 8-pairs with 3-pole overvoltage arrestors (8x13 mm) Quantity: 1 per pack, Installation height: @ 25 mm above module		
Magazine 2/8 for 8-pair modules, unequipped	0.041 kg	6036 2 003-01
Magazine 2/8 for 8-pair modules, equipped with overvoltage arrestors (8x13 mm), 230V, 10kA/10A with fail-safe (6717 3 513-00)	0.080 kg	6036 2 003-04
Basic protection magazine for 10-pairs with 3-pole overvoltage arrestors (8 x 13 mm) Quantity: 1 per pack		
Magazine 2/10 for 10-pair modules, unequipped	0.052 kg	6089 2 023-01
Magazine 2/10 for 10-pair modules, equipped with overvoltage arrestors (8x13 mm), 230V, 10kA/10A with fail-safe (6717 3 513-00)	0.095 kg	6089 2 023-08
Basic protection magazine for 8-pairs with 2-pole overvoltage arrestors (8x6 mm) Quantity: 1 per pack		
Magazine 2/8 for 8-pair modules, unequipped	0.047 kg	6036 2 004-01
Magazine 2/8 for 8-pair modules, equipped with 2-pole overvoltage arrestor (8x6 mm) (metal/ceramic), 90V, 20kA/20A (6717 3 341-00) and fail-safe contact (6417 2 010-00)	0.080 kg	6036 2 004-61
Basic protection magazine for 10-pairs with 2-pole overvoltage arrestors (8x6 mm) Quantity: 1 per pack		
Magazine 2/10 for 10-pair modules, unequipped	0.069 kg	6089 2 024-01
Magazine 2/10 for 10-pair modules, equipped with 2-pole overvoltage arrestor (8x6 mm; metal/ceramic), 230V, 10kA/10A (6717 3 343-01) and fail-safe contact (6417 2 010-00)	0.095 kg	6089 2 024-61

ComProtect Overtoltage Protection

LSA-PLUS and LSA PROFIL Modules

3-Pole Overtoltage Arrestors

The 3-pole overvoltage arrestor (metal/ceramic) is filled with noble-gas and features optional fail-safe (type 8x13) and offers effective 3-point protection for the most varied applications. For 10-pairs, ten overvoltage arrestors are required.

FEATURES

- Reliable limitation of overvoltages
- Diversion of high currents
- Thermal protection by means of fail-safe

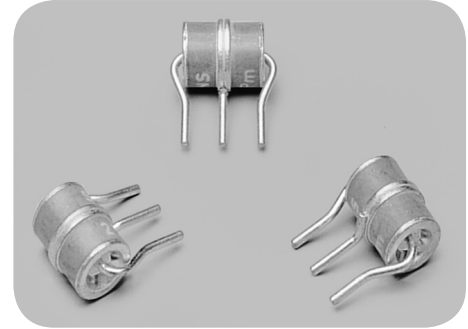

3-pole overvoltage arrestors without fail-safe

ORDERING INFORMATION

Description	Catalog Number
3-pole overvoltage arrestors (8x13 mm) Quantity: 1 per pack Weight/Pack: 0.002 kg	
230V, 10kA/10A, without fail-safe	6717 3 503-00
350V, 10kA/10A, without fail-safe	6717 3 504-00
230V, 20kA/10A, with fail-safe	6717 3 513-90
230V, 10kA/10A, with fail-safe	6717 3 513-00
350V, 10kA/10A, with fail-safe	6717 3 514-00

2-Pole Overtoltage Arrestors

These arrestors are used as replaceable basic protection elements. The 2-pole overvoltage arrestors (with dimensions of 8 x 6 mm) have a metal/ceramic construction. The electrical properties depend on the noble-gas mixture. In order to protect 10-pairs, 20 overvoltage arrestors must be installed.

FEATURES

- Reliable limitation of overvoltages
- Diversion of high currents
- Thermal protection by means of fail-safe contacts



2-pole overvoltage arrestors

ORDERING INFORMATION

Description	Catalog Number
2-pole overvoltage arrestors 8x6 mm, metal/ceramic Quantity: 1 per pack Weight/pack: 0.014 kg	
90V, 20kA/20A	6717 3 341-00
230V, 20kA/20A	6717 3 343-00
230V, 10kA/10A	6717 3 343-01
350V, 20kA/20A	6717 3 344-00

ComProtect Overtoltage Protection

LSA-PLUS and LSA PROFIL Modules

Fail-Safe Contact

These elements are used in conjunction with the 2-pole overvoltage arrestors (gas discharge tubes, GDT), type 8x6 mm, which are installed in the basic protection magazines 2/10 or 2/8 for LSA-PLUS blocks. Their functionality is only guaranteed when they are used in conjunction with metal/ceramic overvoltage arrestors.

In the case of thermal overload (which triggers the fail-safe contact), both the overvoltage arrestor and the fail-safe contact must be replaced.

FEATURES

- Protection against long-term thermal overload
- Replaceable component

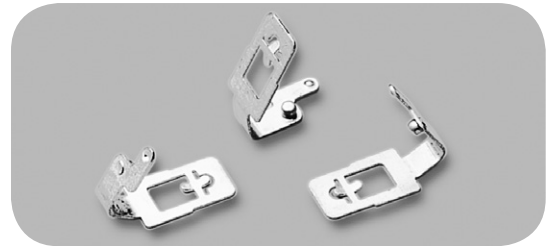

ORDERING INFORMATION

Description	Catalog Number
Fail-safe contact Quantity: 1 per pack Weight/Pack: 0.001 kg	6417 2 010-00

Magazine Cover

The magazine cover is transparent and is used with overvoltage protection magazine 2/10 with gas discharge tube (GDT), 8x6 or 8x13.

FEATURES

- Provides dust protection
- Prevents accidental contact with the overvoltage protection magazine



ORDERING INFORMATION

Description	Catalog Number
Magazine cover Quantity: 1 per pack Weight/Pack: 0.005 kg	
With KRONE logo	6417 3 022-01
Without KRONE logo	6417 3 022-03

ComProtect Overtoltage Protection

LSA-PLUS and LSA PROFIL Modules

Basic Protection Plugs for LSA-PLUS Series 2 Blocks

These plugs are recommended for use as basic overvoltage protection in analog telecommunication systems. The plugs are designed for the partial or complete equipping of LSA-PLUS or LSA PROFIL connection or disconnection modules in conjunction with earth bars and earth contact clips. Jumpering can be performed in a protected distributor module. The protection circuit consists of highly effective 2- or 3-pole overvoltage arrestors and fail-safe contacts for protection of the arrestors against thermal overload.

FEATURES

- Compact form
- Flexible 1-pair design
- Jumpering is possible with protection inserted



Basic protection plug

ORDERING INFORMATION

Description	Weight/Pack	Catalog Number
Basic protection plug for LSA-PLUS Series 2 blocks, 1-pair Installation height: ≈ 21 mm above block Quantity: 10 pieces per pack, including 1 earth bar 2/10		
Plug marking: CP HDA180A1 3-pole overvoltage arrestors Maximum operating voltage: 180V Installation height: ≈ 33 mm above block Quantity: 10 pieces per pack, including 1 earth bar 2/10	0.056 kg	5909 1 064-00

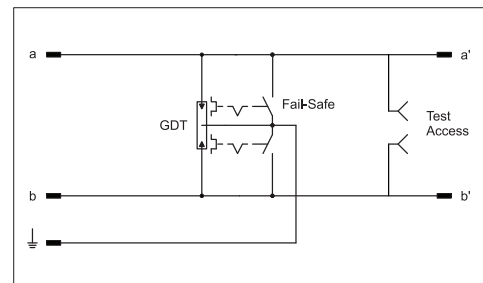

ComProtect Overtoltage Protection

LSA-PLUS and LSA PROFIL Modules

Intermediate Protection Plugs for LSA-PLUS Series 2 Blocks

This plugs are recommended for protection of switching and terminal equipment in conjunction with already installed secondary overvoltage protection. The use of reversible overcurrent protection elements can enhance the response behavior of the basic overvoltage protection component. The plug is designed for the partial or complete equipping of LSA-PLUS or LSA PROFIL connection or disconnection modules in conjunction with earth bars and earth contact clips. The protection circuit consists of a 3-pole overvoltage arrester, fail-safe and overcurrent protection components. An insertion tool (6417 3 117-00) is used to allow jumpering in the protected distributor module.

FEATURES

- Flexible 1-pair form
- Limits overvoltage and overcurrents
- Jumpering is possible with inserted protection
- Provides measurement and test access
- Installation height is approximately 33 mm above the LSA-PLUS or LSA PROFIL module



Intermediate protection plug (ComProtect H)

ORDERING INFORMATION

Description	Weight/Pack	Catalog Number
Intermediate protection plug for LSA-PLUS Series 2 blocks, 1-pair Installation height: @ 33 mm above block		
Plug marking: CP HGB180A1 Maximum operating voltage: 180V, nominal resistance 8 Ohm Quantity: 10 pieces per pack, including 1 earth bar 2/10	0.052 kg	5909 1 063-40
Plug marking: CP HVG180A6 Maximum operating voltage: 180V, resistance balance: 1 Ohm. Inverted circuit configuration for installation in distributor block on the system side, as disturbance is expected from the jumper side Quantity: 10 pieces per pack, including 1 earth bar 2/10	0.052 kg	5909 1 063-30

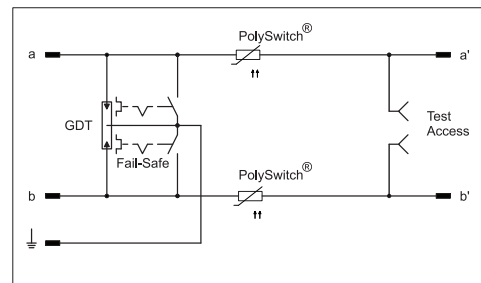

ComProtect Overtoltage Protection

LSA-PLUS and LSA PROFIL Modules

Data Protection Plug for LSA-PLUS Series 2 Blocks

This plug is recommended for unshielded cabling in data transmission networks. The plug is designed for partial or complete equipping of LSA-PLUS or LSA PROFIL disconnection or switching modules in conjunction with earth bars and earth contact clips. An insertion tool (6417 3 117-00) is used to allow jumpering in the protected distributor module.

FEATURES

- Flexible 1-pair form
- Designed for use in networks with high transmission rates
- Short response times
- Installation height is approximately 33 mm above the LSA-PLUS or LSA PROFIL module

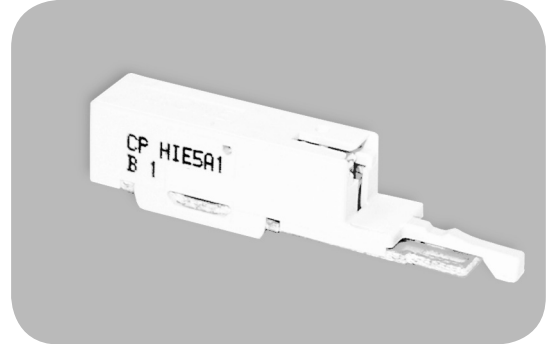

Data protection plug

ORDERING INFORMATION

Description

Data protection plug for LSA-PLUS Series 2 blocks

Plug marking: CP HIE4A1

Maximum operating voltage: 5V,

Quantity: 10 pieces per pack, including 1 earth bar 2/10

Installation height: ≈ 33 mm above block

Weight/Pack

0.052 kg

Catalog Number

5909 1 120-00

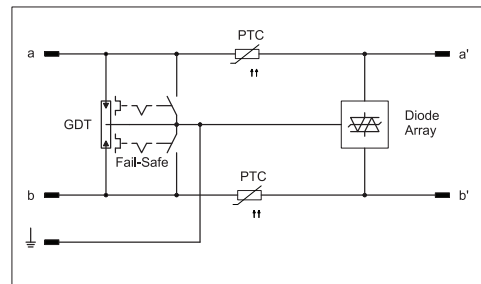

ComProtect Overvoltage Protection

LSA-PLUS and LSA PROFIL Modules

Current Protection Plug for LSA-PLUS Series 2 Blocks

This plug is used when permanent network influences render pure basic protection insufficient. The 1-pair overcurrent plug's (HPP_A2) modular design is used for the partial or complete equipping of LSA-PLUS or LSA PROFIL disconnection or switching modules. It is used as a pure overcurrent protection component, primarily in distribution equipment that is already equipped with overvoltage arrestors. TE Connectivity strongly recommends use of a combination of HPP_A2 and basic protection (ComProtect or overvoltage protection magazines).

FEATURES

- Flexible 1-pair form
- Provides extension of already installed protection
- Jumpering is possible with inserted protection
- Installation height is approximately 33 mm above LSA-PLUS or LSA PROFIL modules

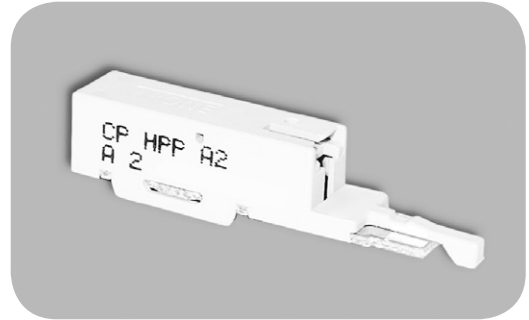

Current protection plug

ORDERING INFORMATION

Description	Weight/Pack	Catalog Number
Current protection plug for LSA-PLUS Series 2 blocks Plug marking: HPP A2 Maximum operating voltage: 5V, Installation height: ≈ 33 mm above block	0.005 kg	5909 2 112-10

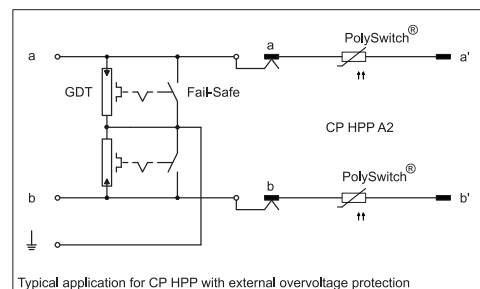

ComProtect Overvoltage Protection

LSA-PLUS and LSA PROFIL Modules

Overvoltage Protection Components and Diodes for Secondary Protection

These plugs are recommended for protection of distribution and terminal equipment in analog, ISDN, HDSL and ADSL telecommunication systems. The plug is designed for partial or complete equipping of LSA-PLUS or LSA PROFIL disconnection or switching modules in conjunction with earth bars and earth contact clips. Jumpering of distribution modules with inserted protection components is possible. The protection circuit consists of a 3-pole overvoltage arrester, fail-safe contact, reversible overcurrent protection components and diodes for secondary protection.

FEATURES

- Flexible 1-pair form
- Short response time
- Jumpering is possible with inserted protection
- Low-voltage variants are available for extended applications
- Installation height is approximately 21 mm above the LSA-PLUS or LSA PROFIL module

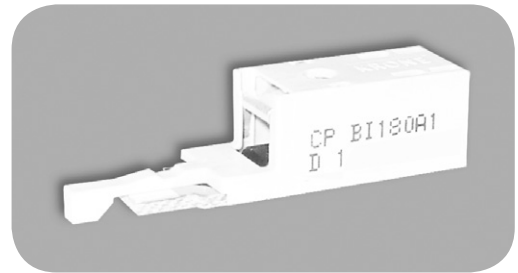

Advanced protection plug

ORDERING INFORMATION

Description	Weight/Pack	Catalog Number
Advanced protection plug for LSA-PLUS Series 2 blocks, 1-pair Protection circuit consists of 3-pole overvoltage arrester, fail-safe contact, reversible overcurrent protection components, diodes for secondary protection Quantity: 10 per pack, including 1 earth bar 2/10 Installation height: ≈ 21 mm above block		
Plug marking: CP BI180A1 Maximum operating voltage: 180V	0.069 kg	5909 1 076-00
Plug marking: CP BI70A2 Maximum operating voltage: 70V For measurement and control technology and industrial bus applications	0.060 kg	5909 1 082-01
Plug marking: CP BI24A1 Maximum operating voltage: 24V For measurement and control technology and industrial bus applications	0.050 kg	5909 1 083-00
Plug marking: CP BI12A1 Maximum operating voltage: 12V For measurement and control technology and industrial bus applications	0.050 kg	5909 1 084-00

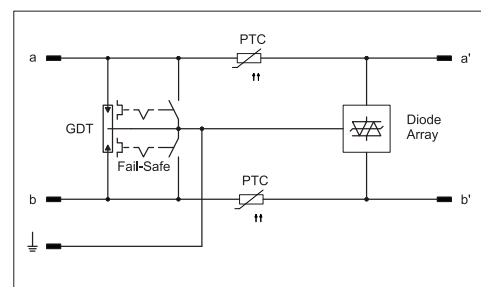

ComProtect Overvoltage Protection

LSA-PLUS and LSA PROFIL Modules

Maintenance-Free Protection Plug for LSA-PLUS Series 2 Blocks

This plug is recommended for protection of distribution and terminal equipment in analog, ISDN, HDSL and ADSL telecommunications systems. The plug is designed for the partial or complete equipping of LSA-PLUS or LSA PROFIL disconnection or switching modules in conjunction with earth bars and earth contact clips. Jumpering of distribution modules with inserted protection components is possible. The protection circuit consists of a 3-pole overvoltage arrester, reversible overcurrent protection components and diodes for secondary overvoltage protection. The overcurrent protection functions as a reversible line fuse.

FEATURES

- Flexible 1-pair form
- Fast response times
- Jumpering is possible with inserted protection
- Optimized service life-time
- Installation height is approximately 21 mm above the LSA-PLUS or LSA PROFIL module

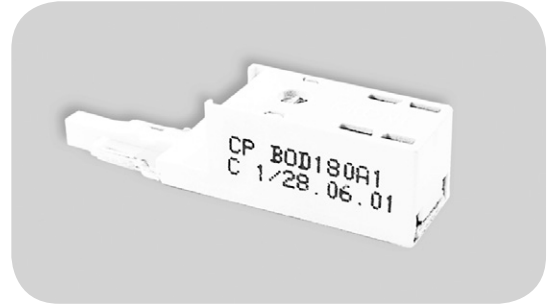

Maintenance-free protection plug

ORDERING INFORMATION

Description	Weight/Pack	Catalog Number
Maintenance-free protection plug for LSA-PLUS Series 2 blocks, 1-pair Quantity: 10 per pack, including 1 earth bar 2/10 Installation height: @ 21 mm above block		
Plug marking: CP BOD180A4 Maximum operating voltage: 180V	0.050 kg	5909 1 078-30
Plug marking: CP BOD270A1 Maximum operating voltage: 270V Used with PCM11 transmission codes with symmetric remote feeding voltage 320V	0.050 kg	5909 1 086-00

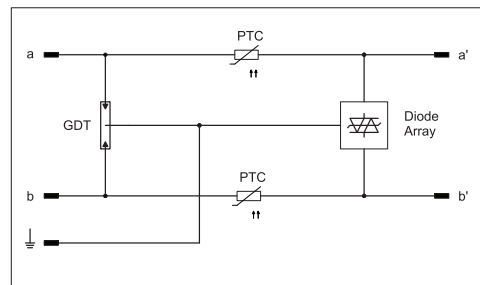

ComProtect Overvoltage Protection

LSA-PLUS and LSA PROFIL Modules

Earth Plug for LSA-PLUS Series 2 Blocks

The earth plug is used for permanent earthing of single pairs in LSA-PLUS or LSA PROFIL disconnection, connection and switching modules. The plug is installed in conjunction with earth bars and earth contact clips.

FEATURES

- Flexible 1-pair form
- Surge-current-proof design
- Can be used with any module

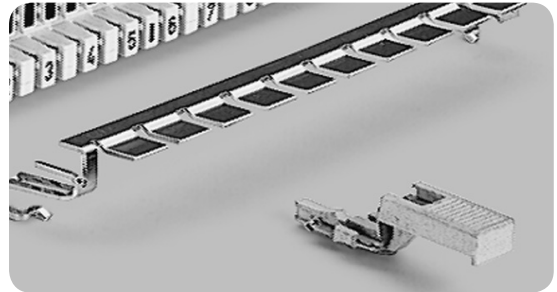

Earth plug

ORDERING INFORMATION

Description	Weight/Pack	Catalog Number
Earth plug for LSA-PLUS Series 2 blocks, 1-pair Plug marking: CP GZA1 Quantity: 10 per pack, including 1 earth bar 2/10	0.060 kg	5909 1 112-00

ComProtect Overtoltage Protection

LSA-PLUS and LSA PROFIL Modules

Earth Bars for LSA-PLUS Modules

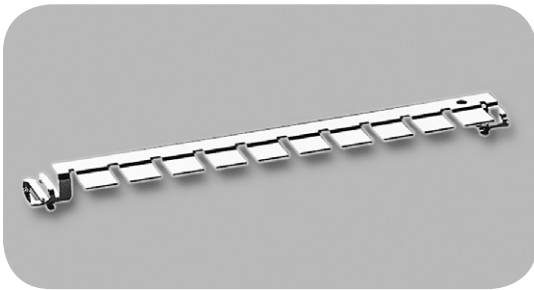

Earth bar for Series 2 and HighBand 10 modules

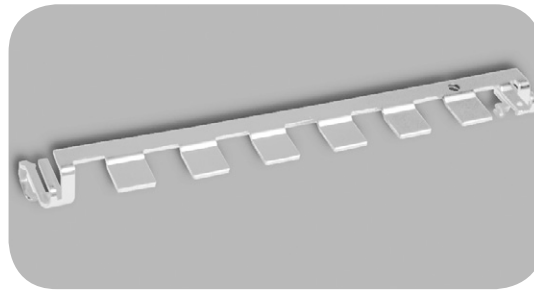

Earth bar for disconnection module 2/6 x abs

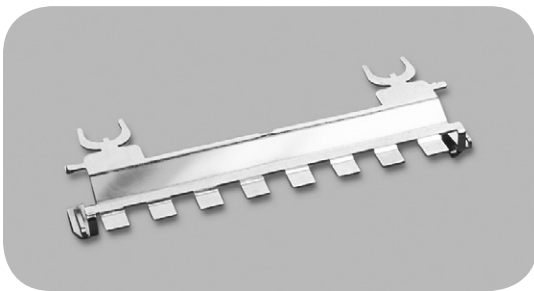

Earth bar for disconnection module 2/8 x abs

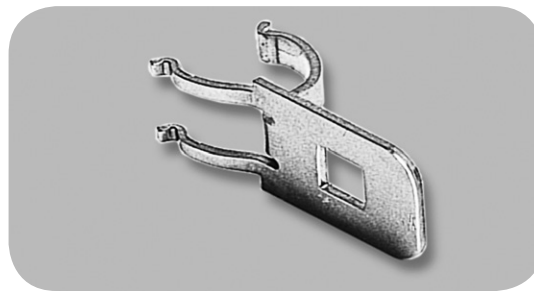

Earth contact clip

The earth bar is used to establish earth connection between ComProtect protection plugs and LSA-PLUS modules installed in a distribution frame. Installation in an LSA PROFIL distribution frame requires the additional installation of earth contact clips.

WARNING: Proper function of the protection plugs is not guaranteed without use of the earth bar. Installation instructions must be followed.

ORDERING INFORMATION

Description	Weight/Pack	Catalog Number
Earth bar for LSA-PLUS Series 2 and HighBand 10 blocks Quantity: 1 per pack NOTE: a set of 10/100 ComProtect protection plugs includes 1/10 earth bars		
Earth bar for 10-pair modules	0.010 kg	5909 3 041-00
Earth bar for 8-pair modules	0.008 kg	5909 3 042-00
Earth bar for LSA-PLUS Series 2 disconnection module, 6 x Line A, Line B, Shield (abs) Quantity: 1 per pack	0.008 kg	5909 3 202-00
Earth bar for LSA PROFIL Series 2 disconnection module, 8 x Line A, Line B, Shield (abs) Quantity: 1 per pack	0.022 kg	5909 3 201-00
Earth contact clip for LSA PROFIL Series 2 modules provides contact between earth bar and profile rod. 2 clips required per module when protection modules are used with Series 2 modules mounted on 12 mm profile rods. Quantity per box: 1000	0.055 kg	6089 3 202-00

ComProtect Overvoltage Protection

Test Device for Protection Components

Test Device

The portable ComProtect test device allows measurement of tolerance limits, interruptions and short circuits in protection circuits, as well as automatic measurement of all positions of the corresponding adapter.

FEATURES

- Supports lifetime testing of 1-pair protection plugs and of magazines
- Battery-operated for mobile use
- Features exchangeable adapters
- Optional software module allows measurement data collection and statistical evaluation
- Enables individual programming of measurement limit values
- Provides automatic measurement
- Offers optical and acoustical fault recognition



The ComProtect test device is delivered in a carrying case. Adapters and software to be ordered separately.

ORDERING INFORMATION

Description	Weight/Pack	Catalog Number
ComProtect test device	5.00 kg	5909 1 302-00
LSA-PLUS 2/10 adapter insert, with receptacle for LSA-PLUS magazine 2/10 and 1-pair ComProtect protection plug	0.750 kg	5909 1 303-00
Software for ComProtect test device Software and adapter cable for data collection and statistical evaluation	0.614 kg	5909 1 304-00

Comprotect Overvoltage Protection

Catalog Number Index

Catalog Number	Description	Page
5909 1 063-30	Plug marking: CP HVG180A6 Maximum operating voltage: 180V, resistance balance: 1 Ohm. Inverted circuit configuration for installation in distributor block on the system side, as disturbance is expected from the jumper side	19
5909 1 063-40	Intermediate protection plug for LSA-PLUS Series 2 blocks, 1-pair Plug marking: CP HGB180A1 Maximum operating voltage: 180V, nominal resistance 8 Ohm	19
5909 1 064-00	Basic protection plug for LSA-PLUS Series 2 blocks, 1-pair, 3-pole overvoltage arrestors Maximum operating voltage: 180V, including 1 earth bar 2/10	18
5909 1 076-00	Advanced protection plug for LSA-PLUS Series 2 blocks, 1-pair, Protection circuit consists of 3-pole overvoltage arrestor, fail-safe contact, reversible overcurrent protection components, diodes for secondary protection Plug marking: CP BII80A1	22
5909 1 078-30	Maintenance-free protection plug for LSA-PLUS Series 2 blocks, 1-pair, Plug marking: CP BOD180A4	23
5909 1 082-01	Plug marking: CP BI70A2 Maximum operating voltage: 70V, For measurement and control technology and industrial bus applications	22
5909 1 083-00	Plug marking: CP BI24A1 Maximum operating voltage: 24V, For measurement and control technology and industrial bus applications	22
5909 1 084-00	Plug marking: CP BII2A1, Maximum operating voltage: 12V, For measurement and control technology and industrial bus applications	22
5909 1 086-00	Plug marking: CP BOD270A1, Maximum operating voltage: 270V, Used with PCM11 transmission codes with symmetric remote feeding voltage 320V	23
5909 1 112-00	Earth plug for LSA-PLUS Series 2 blocks, 1-pair, Plug marking: CP GZA1	24
5909 1 120-00	Data protection plug for LSA-PLUS Series 2 blocks, Plug marking: CP HIE4A1, Maximum operating voltage: 5V,	20
5909 1 302-00	ComProtecttest device	26
5909 1 303-00	LSA-PLUS 2/10 adapter insert, with receptacle for LSA-PLUS magazine 2/10 and 1-pair ComProtect protection plug	26
5909 1 304-00	Software for ComProtect test device, Software and adapter cable for data collection and statistical evaluation	26
5909 2 112-10	Current protection plug for LSA-PLUS Series 2 blocks, Plug marking: HPP A2	21
5909 3 041-00	Earth bar for LSA-PLUS Series 2 and HighBand 10 blocks, NOTE: a set of 10/100 ComProtect protection plugs includes 1/10 earth bars, Earth bar for 10-pair modules	25
5909 3 042-00	Earth bar for 8-pair modules	25
5909 3 201-00	Earth bar for LSA PROFIL Series 2 disconnection module, 8 x Line A, Line B, Shield (abs)	25
5909 3 202-00	Earth bar for LSA-PLUS Series 2 disconnection module, 6 x Line A, Line B, Shield (abs)	25
6036 2 003-01	Basic protection magazine 8-pairs with 3-pole overvoltage arrestors Magazine 2/8 for 8-pair modules, unequipped	15
6036 2 003-04	Basic protection magazine 8-pairs with 3-pole overvoltage arrestors Magazine 2/8 for 8-pair modules, equipped with overvoltage arrestors (8x13 mm), 230V, 10kA/10A with fail-safe (6717 3 513-00)	15
6036 2 004-01	Basic protection magazine for 8-pairs with 2-pole overvoltage arrestors (8x6 mm) Magazine 2/8 for 8-pair modules,	15
6036 2 004-61	Magazine 2/8 for 8-pair modules, equipped with 2-pole overvoltage arrestor (8x6 mm) (metal/ceramic), 90V, 20kA/20A (6717 3 341-00) and fail-safe contact (6417 2 010-00)	15
6089 2 023-01	Basic protection magazine for 10-pairs with 3-pole overvoltage arrestors (8 x 13 mm) Magazine 2/10 for 10-pair modules, unequipped	15
6089 2 023-08	Basic protection magazine 8-pairs with 3-pole overvoltage arrestors Magazine 2/10 for 10-pair modules, equipped with overvoltage arrestors (8x13 mm), 230V, 10kA/10A with fail-safe (6717 3 513-00)	15
6089 2 024-01	Basic protection magazine for 10-pairs with 2-pole overvoltage arrestors (8x6 mm) Magazine 2/10 for 10-pair modules, unequipped	15
6089 2 024-61	Basic protection magazine for 10-pairs with 2-pole overvoltage arrestors (8x6 mm) Magazine 2/10 for 10-pair modules, equipped with 2-pole overvoltage arrestor (8x6 mm; metal/ceramic), 230V, 10kA/10A (6717 3 343-01) and fail-safe contact (6417 2 010-00)	15
6089 3 202-00	Earth contact clip for LSA PROFIL Series 2 modules, provides contact between earth bar and profile rod. 2 clips required per module when protection modules are used with Series 2 modules mounted on 12 mm profile rods.	25

Comprotect Overvoltage Protection

Catalog Number Index

Catalog Number	Description	Page
6417 2 010-00	Fail-safe contact	17
6417 3 022-01	Magazine cover With KRONE logo	17
6417 3 022-03	Magazine cover Without KRONE logo	17
6717 3 341-00	2-pole overvoltage arrestors 8x6 mm, metal/ceramic 90V, 20kA/20A	16
6717 3 343-00	2-pole overvoltage arrestors 8x6 mm, metal/ceramic 230V, 20kA/20A	16
6717 3 343-01	2-pole overvoltage arrestors 8x6 mm, metal/ceramic 230V, 10kA/10A	16
6717 3 344-00	2-pole overvoltage arrestors 8x6 mm, metal/ceramic 350V, 20kA/20A	16
6717 3 503-00	3-pole overvoltage arrestors (8x13 mm) 230V, 10kA/10A, without fail-safe	16
6717 3 504-00	3-pole overvoltage arrestors (8x13 mm) 230V, 10kA/10A, without fail-safe 350V, 10kA/10A, without fail-safe	16
6717 3 513-00	3-pole overvoltage arrestors (8x13 mm) 230V, 10kA/10A, without fail-safe 230V, 10kA/10A, with fail-safe	16
6717 3 513-90	3-pole overvoltage arrestors (8x13 mm) 230V, 10kA/10A, without fail-safe 230V, 20kA/10A, with fail-safe	16
6717 3 514-00	3-pole overvoltage arrestors (8x13 mm) 230V, 10kA/10A, without fail-safe 350V, 10kA/10A, with fail-safe	16

Comprotect Overvoltage Protection

Alphabetical Index

Description	Catalog Number	Page
2-pole overvoltage arrestors 8x6 mm, metal/ceramic 230V, 10kA/10A	6717 3 343-01	16
2-pole overvoltage arrestors 8x6 mm, metal/ceramic 230V, 20kA/20A	6717 3 343-00	16
2-pole overvoltage arrestors 8x6 mm, metal/ceramic 350V, 20kA/20A	6717 3 344-00	16
2-pole overvoltage arrestors 8x6 mm, metal/ceramic 90V, 20kA/20A	6717 3 341-00	16
3-pole overvoltage arrestors (8x13 mm) 230V, 10kA/10A, without fail-safe	6717 3 503-00	16
3-pole overvoltage arrestors (8x13 mm) 230V, 10kA/10A, without fail-safe 230V, 10kA/10A, with fail-safe	6717 3 513-00	16
3-pole overvoltage arrestors (8x13 mm) 230V, 10kA/10A, without fail-safe 230V, 20kA/10A, with fail-safe	6717 3 513-90	16
3-pole overvoltage arrestors (8x13 mm) 230V, 10kA/10A, without fail-safe 350V, 10kA/10A, with fail-safe	6717 3 514-00	16
3-pole overvoltage arrestors (8x13 mm) 230V, 10kA/10A, without fail-safe 350V, 10kA/10A, without fail-safe	6717 3 504-00	16
Advanced protection plug for LSA-PLUS Series 2 blocks, 1-pair, Protection circuit consists of 3-pole overvoltage arrestor, fail-safe contact, reversible overcurrent protection components, diodes for secondary protection Plug marking: CP BI180A1	5909 1 076-00	22
Basic protection magazine 8-pairs with 3-pole overvoltage arrestors Magazine 2/10 for 10-pair modules, equipped with overvoltage arrestors (8x13 mm), 230V, 10kA/10A with fail-safe (6717 3 513-00)	6089 2 023-08	15
Basic protection magazine 8-pairs with 3-pole overvoltage arrestors Magazine 2/8 for 8-pair modules, equipped with overvoltage arrestors (8x13 mm), 230V, 10kA/10A with fail-safe (6717 3 513-00)	6036 2 003-04	15
Basic protection magazine 8-pairs with 3-pole overvoltage arrestors Magazine 2/8 for 8-pair modules, unequipped	6036 2 003-01	15
Basic protection magazine for 10-pairs with 2-pole overvoltage arrestors (8x6 mm) Magazine 2/10 for 10-pair modules, equipped with 2-pole overvoltage arrestor (8x6 mm; metal/ceramic), 230V, 10kA/10A (6717 3 343-01) and fail-safe contact (6417 2 010-00)	6089 2 024-61	15
Basic protection magazine for 10-pairs with 2-pole overvoltage arrestors (8x6 mm) Magazine 2/10 for 10-pair modules, unequipped	6089 2 024-01	15
Basic protection magazine for 10-pairs with 3-pole overvoltage arrestors (8 x 13 mm) Magazine 2/10 for 10-pair modules, unequipped	6089 2 023-01	15
Basic protection magazine for 8-pairs with 2-pole overvoltage arrestors (8x6 mm) Magazine 2/8 for 8-pair modules,	6036 2 004-01	15
Basic protection plug for LSA-PLUS Series 2 blocks, 1-pair, 3-pole overvoltage arrestors Maximum operating voltage: 180V, including 1 earth bar 2/10	5909 1 064-00	18
ComProtecttest device	5909 1 302-00	26
Current protection plug for LSA-PLUS Series 2 blocks, Plug marking: HPP A2	5909 2 112-10	21
Data protection plug for LSA-PLUS Series 2 blocks, Plug marking: CP HIE4A1, Maximum operating voltage: 5V,	5909 1 120-00	20
Earth bar for 8-pair modules	5909 3 042-00	25
Earth bar for LSA PROFIL Series 2 disconnection module, 8 x Line A, Line B, Shield (abs)	5909 3 201-00	25
Earth bar for LSA-PLUS Series 2 and HighBand 10 blocks, NOTE: a set of 10/100 ComProtect protection plugs includes 1/10 earth bars, Earth bar for 10-pair modules	5909 3 041-00	25
Earth bar for LSA-PLUS Series 2 disconnection module, 6 x Line A, Line B, Shield (abs)	5909 3 202-00	25
Earth contact clip for LSA PROFIL Series 2 modules, provides contact between earth bar and profile rod. 2 clips required per module when protection modules are used with Series 2 modules mounted on 12 mm profile rods.	6089 3 202-00	25
Earth plug for LSA-PLUS Series 2 blocks, 1-pair, Plug marking: CP GZA1	5909 1 112-00	24
Fail-safe contact	6417 2 010-00	17
Intermediate protection plug for LSA-PLUS Series 2 blocks, 1-pair Plug marking: CP HGB180A1Maximum operating voltage: 180V, nominal resistance 8 Ohm	5909 1 063-40	19
LSA-PLUS 2/10 adapter insert, with receptacle for LSA-PLUS magazine 2/10 and 1-pair ComProtect protection plug	5909 1 303-00	26
Magazine 2/8 for 8-pair modules, equipped with 2-pole overvoltage arrestor (8x6 mm) (metal/ceramic), 90V, 20kA/20A (6717 3 341-00) and fail-safe contact (6417 2 010-00)	6036 2 004-61	15

Comprotect Overvoltage Protection

Alphabetical Index

Description	Catalog Number	Page
Magazine cover With KRONE logo	6417 3 022-01	17
Magazine cover Without KRONE logo	6417 3 022-03	17
Maintenance-free protection plug for LSA-PLUS Series 2 blocks, 1-pair, Plug marking: CP BOD180A4	5909 1 078-30	23
Plug marking: CP BI12A1, Maximum operating voltage: 12V, For measurement and control technology and industrial bus applications	5909 1 084-00	22
Plug marking: CP BI24A1 Maximum operating voltage: 24V, For measurement and control technology and industrial bus applications	5909 1 083-00	22
Plug marking: CP BI70A2 Maximum operating voltage: 70V, For measurement and control technology and industrial bus applications	5909 1 082-01	22
Plug marking: CP BOD270A1, Maximum operating voltage: 270V, Used with PCM11 transmission codes with symmetric remote feeding voltage 320V	5909 1 086-00	23
Plug marking: CP HVG180A6 Maximum operating voltage: 180V, resistance balance: 1 Ohm. Inverted circuit configuration for installation in distributor block on the system side, as disturbance is expected from the jumper side	5909 1 063-30	19
Software for ComProtect test device, Software and adapter cable for data collection and statistical evaluation	5909 1 304-00	26

KRONE, LSA-PLUS, LSA PROFIL, ComProtect, TE Connectivity and TE connectivity (logo) are trademarks of the TE Connectivity Ltd. family of companies.

The information given herein, including drawings, illustrations and schematics which are intended for illustration purposes only, is believed to be reliable. However, TE Connectivity makes no warranties as to its accuracy or completeness and disclaims any liability in connection with its use. TE Connectivity' obligations shall only be as set forth in TE Connectivity' Standard Terms and Conditions of Sale for this product and in no case will TE Connectivity be liable for any incidental, indirect or consequential damages arising out of the sale, resale, use or misuse of the product. Users of TE Connectivity products should make their own evaluation to determine the suitability of each such product for the specific application.

Contact us:

Tyco Electronics Raychem bvba
Diestsesteenweg 692
3010 Kessel-Lo
Belgium
Tel +32 16 351 011
Fax +32 16 351 697

www.te.com
www.te.com/adckrone

© 2012 Tyco Electronics Raychem bvba, a TE Connectivity Ltd. company. All rights reserved.
Revision 1 TC 1135/CAT/1 09/12 (102386BE Revision 1)

