

FACT optical distribution frame (ODF) solution

Unlocking the potential of every new day

COMMSCOPE®



FACT optical distribution frame (ODF) solution

UNLOCK THE POTENTIAL OF TOMORROW'S HIGH FIBER-COUNT NETWORKS

The demands on your network have never been higher. But where others feel pressure, CommScope finds potential. Fueled by unmatched experience and a history of innovation, we work with you to deliver tailored solutions that unlock the opportunity in your network. Together, we create the cabling and connectivity solutions that keep you moving forward.

In central offices, headends and data centers, demand for bandwidth is growing exponentially. The need to install, access, reconfigure and reroute connections is constant. As the physical layer evolves, termination, splicing, patching and storage requirements surpass the capabilities of standard rack and shelf offerings.

Network managers need a better solution, one that supports rapid deployment, plug-and-play connectivity and high density—all while maximizing the usable density and long-term value of the fiber network. The FACT® optical distribution frame (ODF) solution from CommScope is a compact, **fully front-accessible** solution that maximizes usable density and supports the continued growth of your fiber infrastructure.

As a modular solution, the FACT optical distribution frame (ODF) solution is fully customizable: four modular frame versions for simplistic, clear cable routing, configure and incorporate universal adaptor packs, cabled modules, MPO modules and value-added modules to optimize your network needs. The complete FACT solution provides a flexible, reliable and cost-effective solution to your evolving network needs.

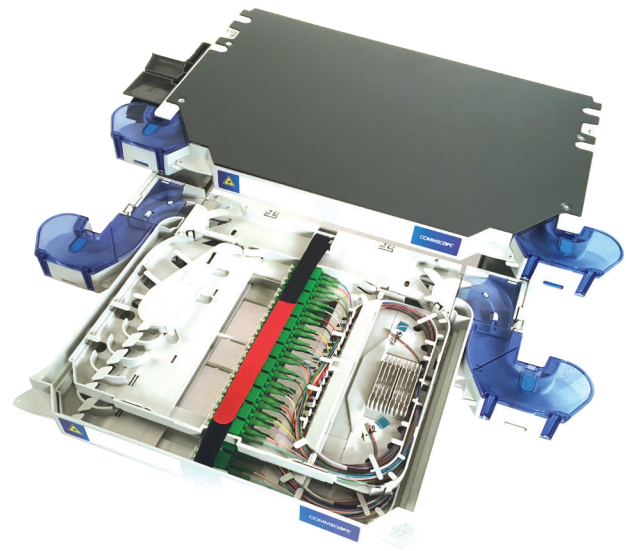

Figure 1: FACT splice-patch chassis

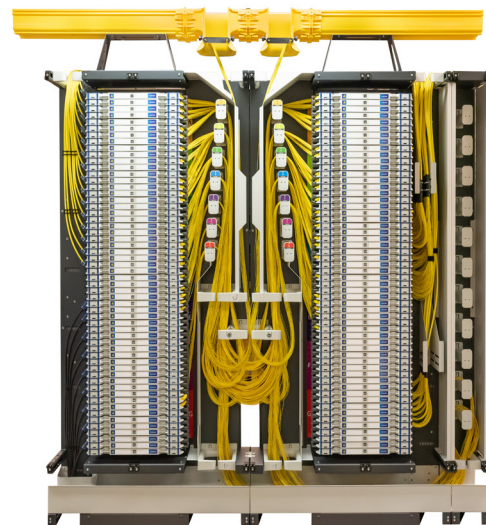

Figure 2: Two fully-populated FACT Frames side-by-side

Powerful benefits

The forward-looking design of the FACT optical distribution frame solution addresses the most pressing needs for your ever-changing fiber network: reliable performance, seamless transition to future applications and a higher overall return on investment.

SCALABLE, MANAGEABLE DENSITY

With a compact, modular and lightweight frame, high-density plug-and-play elements, and full-frontal access, the FACT optical distribution frame system scales smoothly and logically. The innovative design reduces installation time by as much as 50 percent. System maintenance is enhanced as well. All fibers are easily identifiable, clearly routed and individually accessible, allowing technicians to:

- Maximize space by installing frames up against a wall or in back-to-back configurations
- Support up to 2,880 individually accessible LC fiber connections in a fully front-accessible frame
- Locate and trace individual fibers along easy-to-follow cable routing paths
- Complete moves, adds and changes quickly and accurately
- Minimize installation time to live connections through ample room to work
- Reduce inventory and increase component availability with a single fixed patch cord length for all in-rack and panel connections
- Manage interconnects as well as cross-connects
- Perform advanced splicing, management and storage from a single point

LONG-TERM AGILITY

The FACT ODF solution is designed to flex and grow as the fiber needs of your network continue to evolve. Its modular design and simplified installation and management enable long-term agility to meet tomorrow's challenges.

- Supports the any-to-any configurations of today's leaf-and-spine architecture
- Enables on-the-fly addition of splitters, wavelength division multiplexers (WDMs), taps and connectivity modules
- Supports a grow-as-needed approach that avoids overprovisioning and preserves precious capital

LOWER TOTAL COST OF OWNERSHIP

Agility and optimized cable management lower total cost of ownership through maximized usable density, more effective capital deployment and improved operational efficiency:

- Maximize fiber density and manageability
- Deploy standard cable configurations to reduce installation and inventory costs
- Decrease troubleshooting time and need to install or reroute fibers
- Reduce mean time to repair and downtime costs
- Accelerate time to market and time to revenue
- Enhance return on investment (ROI)

CommScope's FACT solution

Minimizes
installation time

Simplified
installation and
management enable
long-term agility to
meet tomorrow's
challenges

Lowers total cost of
ownership through
maximized usable
density

Modular design

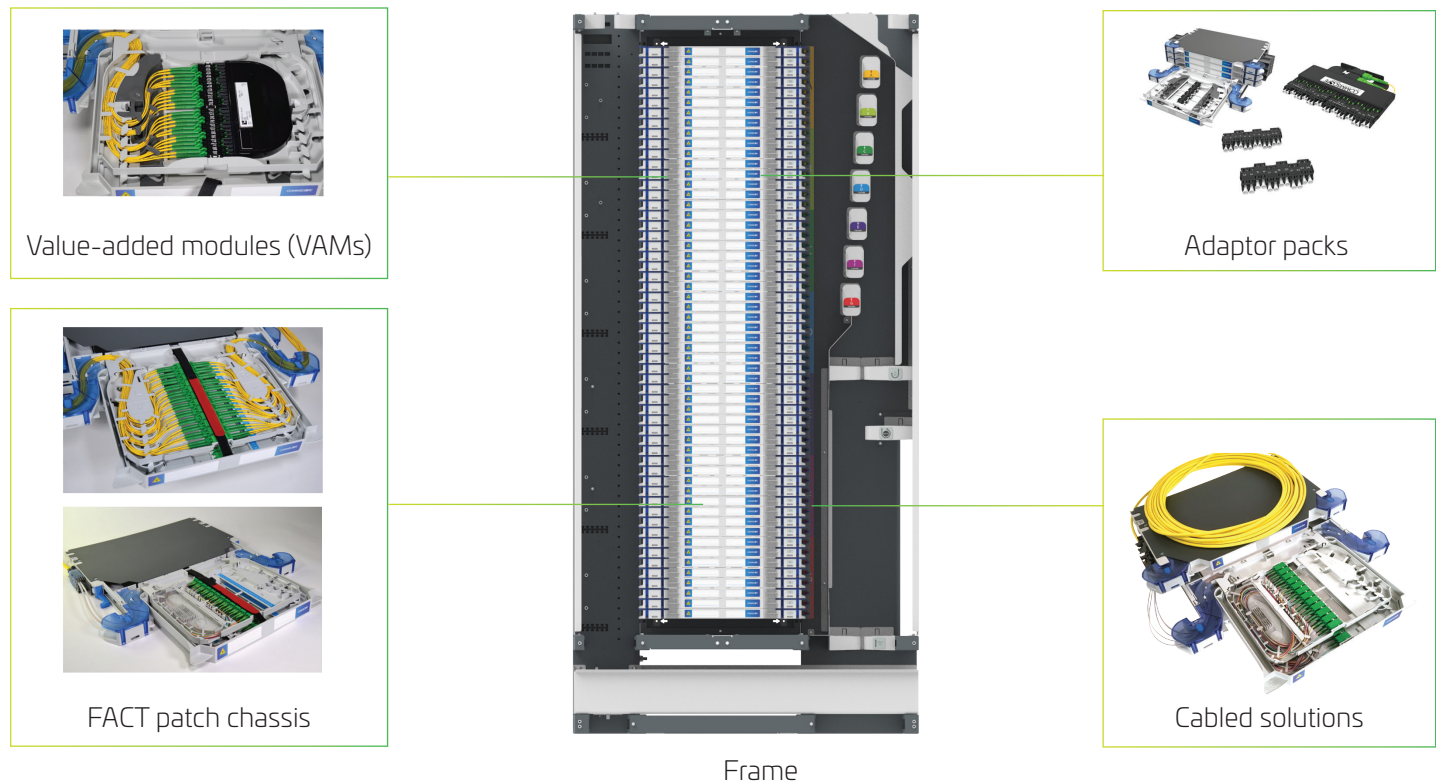

Figure 3: Full frame breakout with horizontal central building blocks

FRAME

The FACT optical distribution frame solution begins with CommScope's modular, lightweight FACT frame. Designed modularly with a small footprint, the fully front accessible FACT frame, can be placed up against a wall or back-to-back in a quad formation to maximize usable density. The frame provides dedicated spots for cable routing and color-coded fiber management, supporting up to 2,880 LC connections in a single frame. The cross-connect FACT frame can be designed and easily installed with cable routing on either side of the frame which includes backplate numbering allowing for simple tracking of fibers whether you route from top to bottom or vice-versa. One standard patch cord length can reach any position in a back-to back configuration, reducing the number of cable lengths required. The FACT frame accommodates not only FACT shelving, but standard 19 inch shelving as well allowing you to increase your density while utilizing your current equipment. The FACT Frame is compatible with a range of accessories such as side panels, doors and cable attachment plates.

ELEMENTS AND CHASSIS

FACT elements may be deployed individually as a single-element chassis or grouped with other elements for higher density solutions. Each element measures 30.95 mm (1.22 in.) tall, 30 percent less than the standard HU (44.45 mm/ 1.75 in.). Each element supports two hinged trays that provide full front access to both sides of all connections and clear visibility of all ports. Four chassis types—patch-only, patch-splice, pre-cabled and NG4—enable customization of the FACT optical distribution frame to support virtually any application.

ADAPTOR PACKS

FACT adaptor packs are available in LC 12-pack, SC six-pack and MPO four-pack configurations, and are compatible with singlemode and multimode, angled and ultra-polished connectors. All adaptor packs are compatible with the universal FACT NG4 chassis. Two adaptor packs snap into a single access tray. Staggered adaptor ports improve access for quick and easier connector insertion and removal, and help to clearly identify individual adaptor ports.

MPO MODULES

FACT MPO modules are used with the universal FACT NG4 chassis. The front of the MPO module offers the same familiar interface as standard LC and SC adaptor modules. The rear of the module features an ultra low loss (ULL) MPO adaptor that allows direct connection to preterminated MPO trunk cables—so you can provision up to 24 circuits at a time.

VALUE-ADDED MODULES

NG4access® value-added modules enhance optical transport systems by providing flexible, easy-to-incorporate optical components that increase fiber capacity, enhance system monitoring, or distribute signals to multiple subscribers. Value-added modules are used with the universal FACT NG4 chassis.

ACCESSORIES (SOLD SEPARATELY)

Accessories for the FACT chassis include cable termination components for all cable sizes and cable types plus doors and panels for the frame.

SPLICE-ONLY CHASSIS

The FACT splice-only chassis is a multipurpose splice shelf featuring single-circuit and single-element fiber management.

PATCH CORDS

The FACT optical distribution frame system solution works best when using fixed patch cord lengths within the same frame, or between adjacent frames. Patch cords with a diameter of 1.8 mm/0.07 in. or less enable an effective usable density of 2,688 connections per frame.

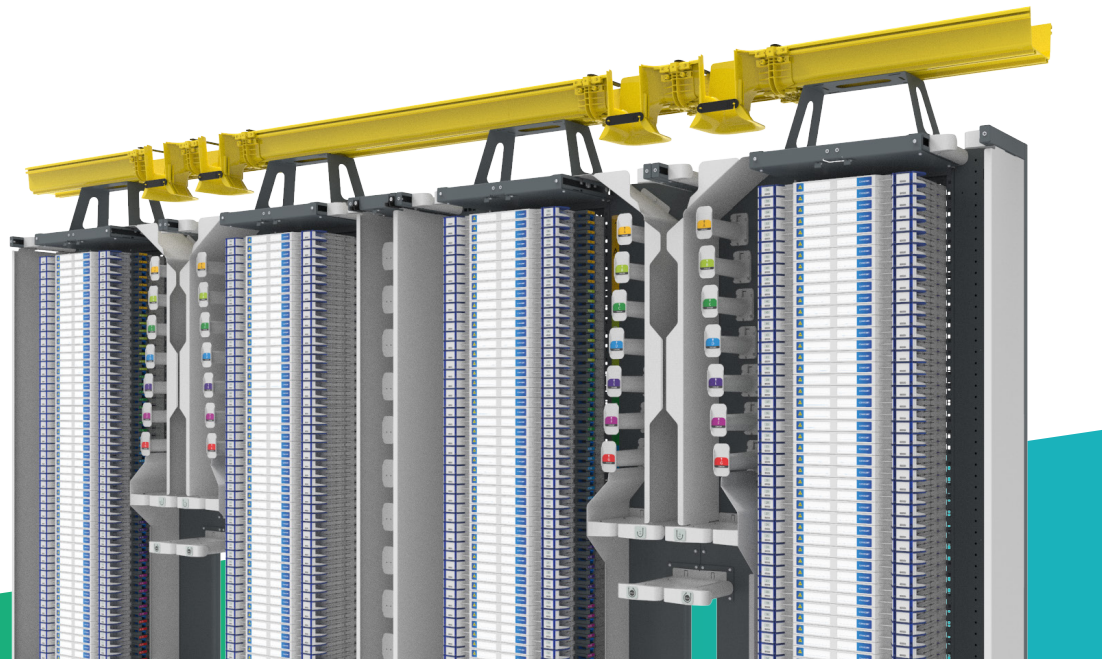

Optimal access for quick and easy
connector insertion and removal

FACT optical distribution frame (ODF) platform at a glance

APPLICATION	
General	Medium to large front access fiber applications
Location	Main distribution area or head of row
Function	Cross-connect (CC, with CC-frame) or interconnect (IC, with IC-frame)
DIMENSIONS	
Width	900 mm (IC-frame) or 1050 mm(CC-frame) (35" or 42")
Depth	300 mm (12")
Height	2200 mm (87")
INSTALLATION PRACTICES	
Patching direction	In tray
CC-frame: max frames per lineup at max density (recommended)	4 (without Fiber Guide) - equals 10752 single LC-connections 16 (with Fiber Guide) - equals 43008 single LC-connections
IC-frame	Typically single frame application
Recommended Patch Cord OD	SC: <= 2 mm LC: <= 1.8 mm
On frame splicing	Yes, with density reduction
Jumper Slack Storage Location	On Frame
Interconnect (IC and CC-frame)	Excellent
Cross-connect (CC-frame)	Excellent
CAPACITY	
Connctions/Frame SC/LC	CC: 1344/2688 - IC: 1440/2880
Connections/Frame MPO 12 Fiber	CC: 10752 - IC: 11520
Connections/Frame MPO 24 Fiber	CC: 21504 - IC: 23040
Splices/Frame: Splice-Patch chassis	CC: 2688 - IC: 2880
Splices/Frame: Splice chassis (with SMOUV protector)	CC: 4032 - IC: 4320
Connection Density for frame width 1050 mm	SC: 3733/343
	LC: 7466/686
	MPO: 29866/2745
Elements per Frame	CC: 56 - IC: 60
VAM (Value Added Module) Capacity	Yes (FACT-NG4 chassis only)
NG4 Adapter packs Capacity	Yes (FACT-NG4 chassis only)
NG4 MPO Modules Capacity	Yes (FACT-NG4 chassis only)
NG4 Cabled Modules Capacity	Yes (FACT-NG4 chassis only)
SPECIFICATIONS	
Compliance	IEC 6300-2
Seismic rating	Zone 2

The Frame

THE FRAME

CommScope's all-purpose, easy-to-use FACT frames are designed to meet today's and tomorrow's high-density network needs. The front access frame provides full access to both sides of all connections, for a more compact effective footprint. The frame ships in a lightweight, condensed kit for easy handling, storage and transport. It is easy to install onsite—even by a single operator in less than 30 minutes.

Fact Frames are designed for agility. They can be placed as a stand-alone, or together and can be mounted on the floor, against a wall, side-by-side or back-to-back. Engineered bend control during routing maintains superior optical performance and easy access to cables, pigtails and jumpers during installation, and all of this during the total life time of the frame over multiple equipment generations.

Cable attachment plates are incorporated into the side ducts, and a range of accessories such as door kits, top and side panels, over-length storage bays, and extra cable attachment plates are available as well.

AVAILABLE FOR CROSS-CONNECT OR INTERCONNECT APPLICATIONS

The FACT Cross-connect frame is the best-in-class frame for applications with a medium or high "moves, adds and changes" frequency (MAC-frequency). FACT cross-connect frames can be used in a single frame application, or when placed together, can be set up in multiple frame configurations to suit any space requirement and allows for additional ease of access to cables during operation, maintenance and upgrades. For larger lineups, multiple FACT cross-connect frames can be deployed side-by-side. Each cross-connect frame accommodates 2688 single LC connections.

The interconnect FACT frame is typically used in a single frame application with lower MAC-frequency, offering a superior density with 2880 single LC connections on a smaller footprint.

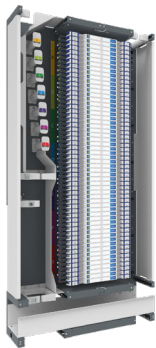

Figure 4: Single Cross Connect frame, recommended patch cord length for all cross-connects is 5 meters (17 ft.).

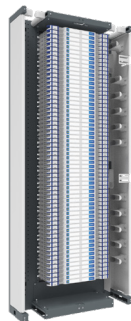

Figure 4b: Interconnect frame with side panels

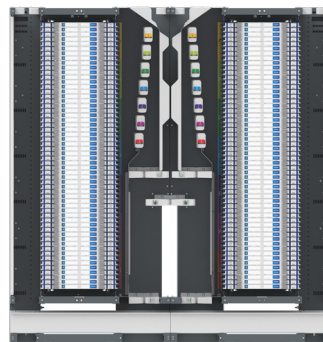

Figure 5: Cross Connect twin frame deployed side-by-side.

Recommended patch cord length for all cross connects is 5 meters (17 ft) inside the twin frame.

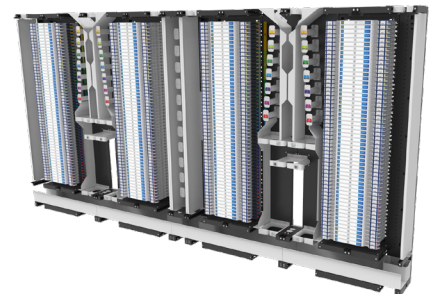

Figure 6: Cross Connect Four-frame block, deployed side-by-side, with side panels and with overlength storage bay in between the two twin frames.

Recommended patch cord length for the cross connects between the two twin frames is 10 meters (34 ft).

FRAME ORDERING INFORMATION

Description	Dimensions: H x W x D	Max. termination capacity	Catalog number	Catalog description
Cross-connect frame, patching on the left	2200 mm x 1050 mm x 300 mm (87 in. x 41 in. x 12 in.)	2688 single LC or 1344 SC connections per frame	760243094	FACT-FRCCLHP22
Cross-connect frame, patching on the right	2200 mm x 1050 mm x 300 mm (87 in. x 41 in. x 12 in.)	2688 single LC or 1344 SC connections per frame	760243095	FACT-FRCCRHP22
Interconnect frame, patching on the right	2200 mm x 900 mm x 300 mm (87 in. x 35 in. x 12 in.)	2880 single LC or 1440 SC connections per frame	760243096	FACT-FRICRHP22
Path cord overlength management bay	2200 mm x 200 mm x 300 mm (87 in. x 8 in. x 12 in.)	n/a	760243097	FACT-FROLB22
<p>All frame kits include:</p> <ul style="list-style-type: none"> - Wall and back-to-back connection kit - Side-to-side connection kit - Earthing kit - Adjustable feet - Intuitive installation instructions - Color label kit for spool identification and intuitive patch cord routing - Required hardware and fasteners - Pre-installed position number identification strip for FACT-style and 19"-style. 				

FRAME ACCESSORIES ORDERING INFORMATION

Description	Catalog number	Catalog description
Cross-connect door kit. Set of two doors with two door handles per door. The door handles are compatible with half cylinder locks according to DIN 18252 (EN 1303). Locks not included.	760243098	FACT-FRCCD22
Cross-connect side panel kit (set of two panels)	760243099	FACT-FRCCP22
Interconnect door kit. Set of two doors with two door handles per door. The door handles are compatible with half cylinder locks according to DIN 18252 (EN 1303). Locks not included.	760243100	FACT-FRICD22
Patch cord overlength bay door. Set of one door with two door handles. The door handles are compatible with half cylinder locks according to DIN 18252 (EN 1303). Locks not included.	760243101	FACT-FROLBD22
Fiber guide fixation kit	760243110	FACT-FRACCFG
Kit with two half cylinder locks according to DIN 18252 (EN 1303). Two lock kits are required for a frame door kit, only 1 lock kit required for OLB door kit.	760245341	FACT-FRACCDL2(2-pack)
<p>All frame accessory kits include:</p> <ul style="list-style-type: none"> - Intuitive installation instruction - Required hardware and fasteners 		

FACT chassis types

The building blocks of the FACT optical distribution frame system are the FACT chassis. FACT chassis can be deployed individually as a single-element chassis, or up to six similar elements can be combined into high fiber-count FACT chassis.

The single-element FACT chassis measures 30.95 mm (1.22 in.) tall, 30 percent less than the standard HU/1RU (44.45 mm/1.75 in.). Each FACT element features two hinged trays, providing full front access to both sides of all connections and clear visibility of all ports. There are four FACT chassis types.

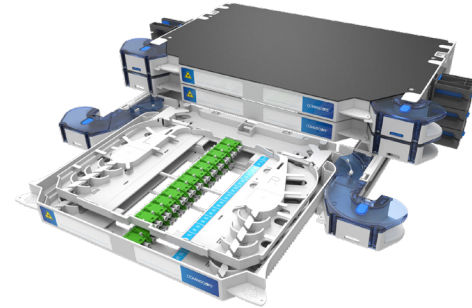

Figure 7: Three element patch-only chassis

PATCH-ONLY CHASSIS

The FACT patch-only chassis supports cross-connect and interconnect applications and is available with SC and LC adaptors. The FACT patch-only chassis accommodates 24 SC connections or 48 single LC connections per element.

PATCH-ONLY CHASSIS: ORDERING INFORMATION

FACT- ¹XX PAT ²XX

Element count

1	1E	One element
	2E	Two elements
	3E	Three elements
	4E	Four elements
	5E	Five elements
	6E	Six elements

Adaptor types, Port count

2	S1	SC UPC, 24 ports per element
	S2	SC APC, 24 ports per element
	S4	SC OM4, 24 ports per element
	L1	LC UPC, 48 single LC ports per element
	L2	LC APC, 48 single LC ports per element
	L4	LC OM4, 48 single LC ports per element

SPLICE-PATCH CHASSIS

Preterminated with pigtailed, the FACT splice-patch chassis enables splicing of OSP or ISP cables directly on the frame with no loss of density. Available with SC or LC preterminated connections, the high-density chassis accommodates 24 SC or 48 single LC connections per FACT element and uses the EIA/TIA 598 color-coding standard.

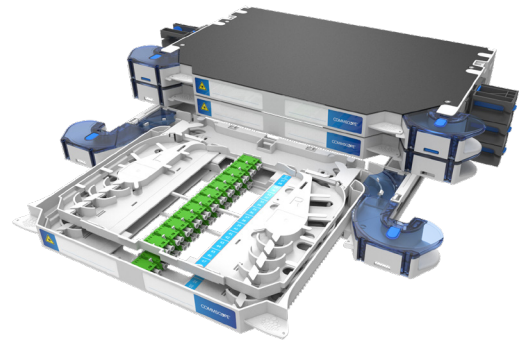

Figure 8: Two-element splice-patch chassis with left-side patching

SPLICE-PATCH CHASSIS ORDERING INFORMATION

FACT- 1
XX 2
X H P 3
XX 4
X

Element count

1	1E	One element
	2E	Two elements
	3E	Three elements
	4E	Four elements
	5E	Five elements
	6E	Six elements

Patch cord side

2	L	Left-hand patch
	R	Right-hand patch

Splice holder/protector (included)

4	S	SMOUV
	A	ANT

Adaptor/connector types, Port count

3	S1	SC UPC, C-grade, 24 ports per element
	S2	SC APC 8°, C-grade, 24 ports per element
	SF	SC UPC, B-grade, 24 ports per element
	SG	SC APC 8°, B-grade, 24 ports per element
	S4	SC OM4, 24 ports per element
	L1	LC UPC, C-grade, 48 single LC ports per element
	L2	LC APC, C-grade, 48 single LC ports per element
	LF	LC UPC, B-grade, 48 single LC ports per element
LG	LC APC, B-grade, 48 single LC ports per element	
L4	LC OM4, 48 single LC ports per element	

COLOR CODING

Fiber 1	Blue
Fiber 2	Orange
Fiber 3	Green
Fiber 4	Brown
Fiber 5	Grey
Fiber 6	White
Fiber 7	Red
Fiber 8	Black
Fiber 9	Yellow
Fiber 10	Purple
Fiber 11	Pink
Fiber 12	Turquoise

Note: All fibered standard FACT products use EIA/TIA 598 color coding

*Single mode connector performance grades B & C according to IEC 61755-1.

PRE-CABLED CHASSIS

The FACT pre-cabled chassis is supplied with connectorized cables from 24 fibers to 144 fibers, and a stub on the far end. It is available for indoor cable in lengths up to 300 meters. The pre-cabled chassis accommodates 24 SC or 48 single LC connections per FACT element. All pre-cabled FACT chassis use EIA/TIA 598 color-coding standard.

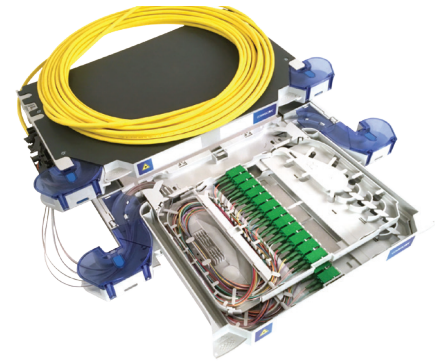

Figure 9: Two-element pre-cabled chassis with 96 indoor microsheet cable and right-side patching

PRE-CABLED CHASSIS ORDERING INFORMATION

FACT- **1** **2** H P **3** **4** - **5** **6**

1 Element count

1E	One element
2E	Two elements
3E	Three elements
4E	Four elements
5E	Five elements
6E	Six elements

2 Patch cord side

L	Left-hand patch
R	Right-hand patch

3 Adaptor/connector types, Port count

S1	SC UPC, C-grade, 24 ports per element
S2	SC APC 8°, C-grade, 24 ports per element
SF	SC UPC, B-grade, 24 ports per element
SG	SC APC 8°, B-grade, 24 ports per element
S4	SC OM4, 24 ports per element
L1	LC UPC, C-grade, 48 single LC ports per element
L2	LC APC, C-grade, 48 single LC ports per element
LF	LC UPC, B-grade, 48 single LC ports per element
LG	LC APC, B-grade, 48 single LC ports per element
L4	LC OM4, 48 single LC ports per element

4 Splice holder/protector

S	SMOUV
A	ANT

5 Cable length

010	10 m (33 ft.)	100	100 m (328 ft.)
020	20 m (66 ft.)	150	150 m (492 ft.)
030	30 m (98 ft.)	200	200 m (656 ft.)
050	50 m (164 ft.)	250	250 m (820 ft.)
075	75 m (246 ft.)	300	300 m (984 ft.)

6 Cable type

ID	24 fiber Indoor Micro-Tube cable, SM G657A1 = yellow; OM4 = Aqua, EN50575 CPR Cable EuroClass Dca
IF	48 fiber Indoor Micro-Tube cable, SM G657A1 = yellow; OM4 = Aqua, EN50575 CPR Cable EuroClass Dca
IG	72 fiber Indoor Micro-Tube cable, SM G657A1 = yellow; OM4 = Aqua, EN50575 CPR Cable EuroClass Dca
IK	96 fiber Indoor Micro-Tube cable, SM G657A1 = yellow; OM4 = Aqua, EN50575 CPR Cable EuroClass Dca
IH	144 fiber Indoor Micro-Tube cable, SM G657A1 = yellow; OM4 = Aqua, EN50575 CPR Cable EuroClass Dca
CD	24 fiber Indoor Micro-Tube cable, Fiber: G657A1, Yellow jacket, EN50575 CPR Cable EuroClass Cca
CF	48 fiber Indoor Micro-Tube cable, Fiber: G657A1, Yellow jacket, EN50575 CPR Cable EuroClass Cca
CG	72 fiber Indoor Micro-Tube cable, Fiber: G657A1, Yellow jacket, EN50575 CPR Cable EuroClass Cca
CK	96 fiber Indoor Micro-Tube cable, Fiber: G657A1, Yellow jacket, EN50575 CPR Cable EuroClass Cca
CH	144 fiber Indoor Micro-Tube cable, Fiber: G657A1, Yellow jacket, EN50575 CPR Cable EuroClass Cca
OD	24 fiber In/Outdoor Microsheath Breakout cable, G657A1, black, EN50575 CPR Cable EuroClass Dca
OF	48 fiber In/Outdoor Microsheath cable, G657A1, black, EN50575 CPR Cable EuroClass Dca
OG	72 fiber In/Outdoor Microsheath cable, G657A1, black, EN50575 CPR Cable EuroClass Dca
OK	96 fiber In/Outdoor Microsheath cable (SM = black), G657A1, black, EN50575 CPR Cable EuroClass Dca
OH	144 fiber In/Outdoor Microsheath cable (SM = black), G657A1, black, EN50575 CPR Cable EuroClass Dca

Note: Cable fiber count needs to match the FACT-chassis port count

FACT NG4 CHASSIS

The universal FACT NG4 chassis supports NG4access connectivity packs and modules that snap into the FACT NG4 chassis. In addition to SC, LC and MPO adaptor packs, it also accommodates MPO-to-LC or MPO-to-SC modules, cabled modules and single high value-added modules (VAMs).

The FACT NG4 element includes two trays; each element can accommodate:

- Four LC or SC adaptor packs
- Two MPO modules
- Two 24-fiber LC cabled modules
- Two 12-fiber SC cabled modules
- Two single high value added modules (VAMs)



Figure 10: Four-element FACT NG4 chassis with LC adaptor pack



Figure 11: Single-element FACT NG4 chassis with right-exit MPO module

FACT NG4 CHASSIS: ORDERING INFORMATION

FACT- 1
XX NG4

Element count

1	1E	One element
	2E	Two elements
	3E	Three elements
	4E	Four elements
	5E	Five elements
	6E	Six elements

Universal adaptor packs

FACT universal adaptor packs are designed to accept singlemode and multimode connections with ultra-polished or angle-polished connectors. A staggered adaptor design allows technicians to easily identify and access individual connections without disturbing adjacent circuits and eliminates the need for insertion or extraction tools.

Each FACT element supports up to four universal adaptor packs; two LC12, SC6 or MPO4 adaptor packs can be installed per tray.

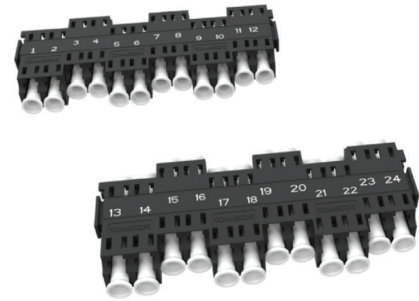

Figure 12: LC12 universal adaptor packs

UNIVERSAL ADAPTOR PACKS ORDERING INFORMATION			
Description	Capacity	Dimensions (H x W x D)	Catalog number
Snap-in LC12 universal adaptor pack (two packs w/labels)	24 single LC connections	84 mm x 33 mm x 10 mm (3.3 in. x 1.3 in. x 0.4 in.)	NG4-APLC120000
Snap-in SC6 universal adaptor pack (two packs w/labels)	12 SC connections		NG4-APSC060000
Snap-in MPO adaptor four-pack, Method A (key up/down) (two packs w/labels)	8 MPO connections		NG4-APMP040000
Snap-in MPO adaptor four-pack, Enhanced Method B (key up/up) (two packs w/labels);	8 MPO connections		NG4-APMP0400EB

MPO modules

FACT MPO modules enable technicians to route and install higher fiber counts faster and more easily, while simplifying inventory and ordering. The front interface for LC connectors is identical to the cabled module, while the rear integrates a low-loss MPO adaptor—enabling installers to quickly connect MPO trunk cables for rapid installation and turn-up. This module also supports direct connection to electronics, fiber tie cables or top-of-rack systems such as CommScope’s Rapid panels or MFPS panel. The MPO module snaps into place within the FACT NG4 tray, and each FACT NG4 element supports up to two MPO modules. Standard available wiring methods are method A and Method B Enhanced.

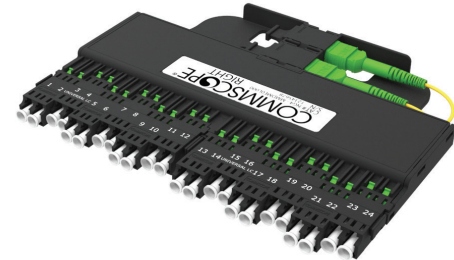
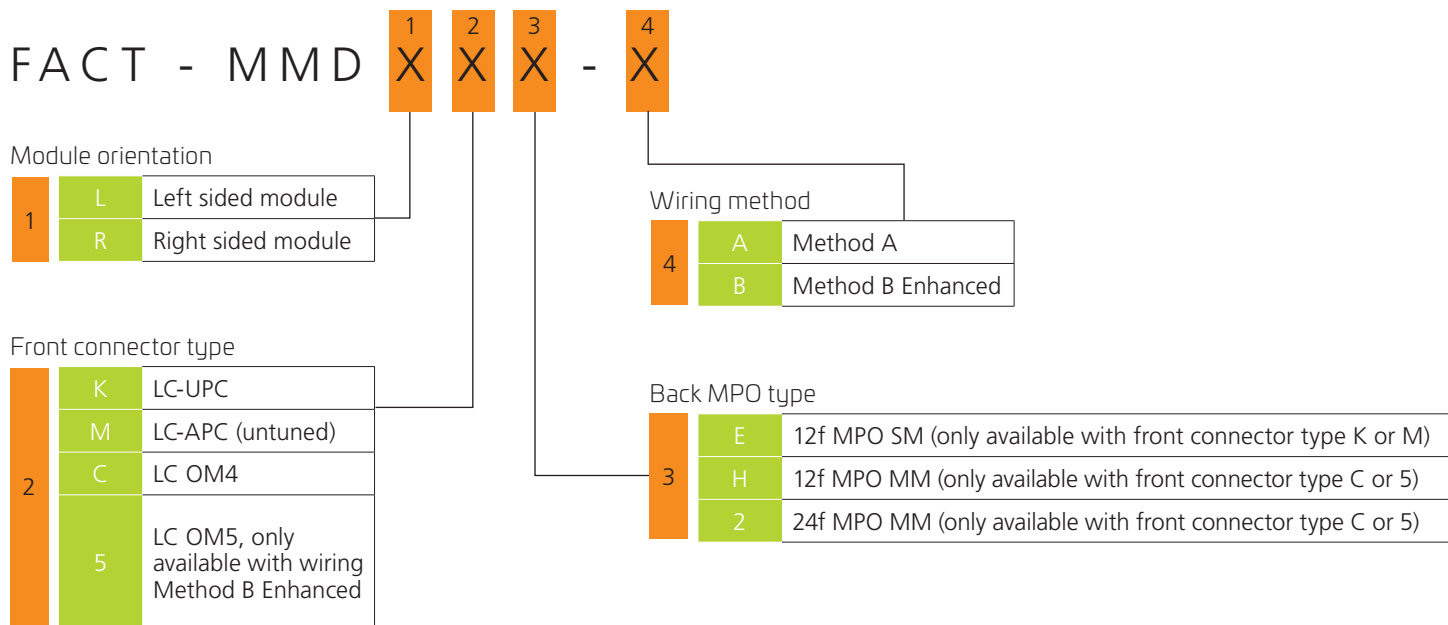

Figure 13: Right-exit MPO module with LC adaptors

MPO MODULES: ORDERING INFORMATION



Value-added modules (VAMs)

VAMs FOR COARSE/DENSE WAVELENGTH DIVISION MULTIPLEXING

The FACT portfolio also includes Single High value-added modules (VAMs) for coarse Wavelength Division Multiplexing (CWDM) and Dense Wavelength Division Multiplexing (DWDM). These VAMs are used to combine (or separate) two or more signals with different wavelengths to more efficiently use existing fiber.

CWDM VAM modules provide a wide range of wavelength combinations typically from 4 to 8 channels while DWDM VAM modules are typically used for higher channel count requirements and combine up to 16 DWDM channels in a single high module.

Both CWDM and DWDM VAMs support 12 SC or 24 LC front facing connectors. Optional test and upgrade ports enable rapid signal turn-up and simplified test access.

For details on available configurations, please contact your account manager or field application engineer.

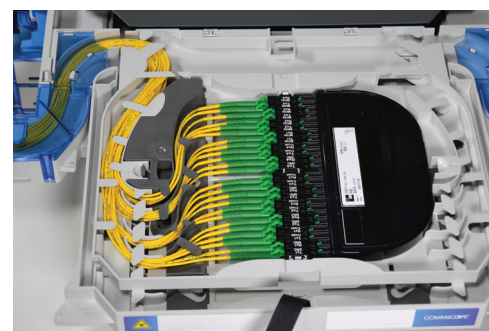

Figure 14: Value-added module shown loaded into a FACT NG4 chassis

VAMs FOR MONITORING CIRCUITS

The FACT portfolio also includes Single high value-added modules (VAMs), which enable monitoring and testing of single-mode and multimode optical signals. These non-intrusive monitoring VAMs provide a wide range of tap ratios to meet specific application requirements. Technicians can easily monitor traffic at a single point to identify signal degradation and locate failures more quickly. Multimode monitoring VAMs operate at data rates of 10Gbps or below. Monitoring VAMs support 12 SC or 24 LC front facing connectors.



Figure 15: Single high NG4access VAM

SINGLEMODE MONITOR VAMs ORDERING INFORMATION

Description	Connector	Orientation	MID
4 circuits 60/40 Tap Ratio	LC UPC	Left	NG4-VMKLF4J
4 circuits 50/50 Tap Ratio	LC UPC	Left	NG4-VMKLF4C

MULTIMODE MONITOR VAMs ORDERING INFORMATION

Description	Connector	Orientation	MID
4 circuits 70/30 Tap Ratio	LC Multimode	Left	NG4-VMKNLF4H010GM
4 circuits 60/40 Tap Ratio	LC Multimode	Left	NG4-VMKNLF4J010GM
4 circuits 50/50 Tap Ratio	LC Multimode	Left	NG4-VMKNLF4C010GM

VAMs FOR SPLITTING SIGNAL

The FACT portfolio also includes Single high value-added modules (VAMs). Splitter VAMs are used to split (or combine) optical signal power from one fiber to multiple fibers splitter VAMs can be used for signal distribution in PON networks. Splitter VAMs support 12 SC or 24 LC front facing connectors.

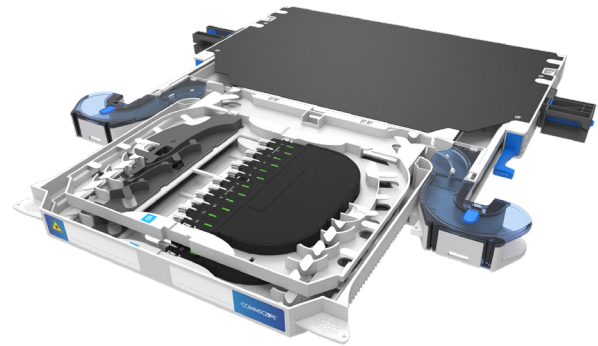

Figure:16: Element FACT NG4 chassis chassis with two single high VAMs.

ORDERING INFORMATION

Description	Connector	Orientation	MID
8 Circuits symmetrical split (1x2 splitter)	LC / APC	Left	NG4-VSMLF8C
4 Circuits symmetrical split (1x4 splitter)	LC / APC	Left	NG4-VSMLF44
2 Circuits symmetrical split (1x8 splitter)	LC / APC	Left	NG4-VSMLF28
1 Circuits symmetrical split (1x16 splitter)	LC / APC	Left	NG4-VSMLF116

Accessories

FACT CABLE TERMINATION KITS

FACT cable termination kits enable quick and easy termination of all commonly used cables either with Cable Termination Units (CTUs) directly on the FACT chassis or with Cable Attachment Plates for the larger and stiff cables in the cable side duct.

FACT CTUs are specifically designed for termination of most commonly used cables (diameter range: 5 mm to 15mm) directly on the FACT chassis. This allows the installer to pre-terminate a cable on the CTU outside the frame. When using the FACT Frame solution, it is recommended to use the FACT-FRACCCTUx series. This CTU series which can only be used with the FACT frame, accommodates with stiffer cables and cable diameters up to 15 mm.

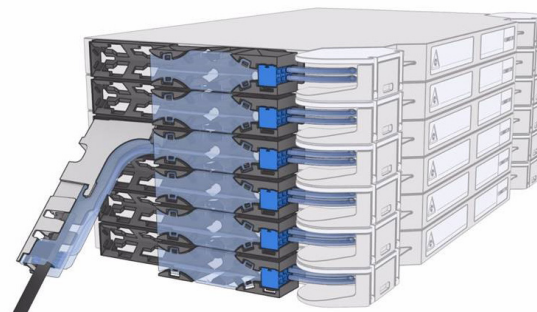

Figure:17: Installed FACT-FRACCCTU6E with cable exit in the left bottom corner.

FACT Cable Attachment Plates are used for securing very stiff and/or thick cables and fanout cables in the side duct.

If you are using a FACT shelf in a FIST-GR3 frame or another compatible frame, please use the FACT-ACCCTU series and FIST-GR3 cable attachment and backplates listed in the appendix.

CABLE TERMINATION UNIT (CTU) FACT FRAME ORDERING INFORMATION				
Description	Compatible Frame Type(s)	Diameter range (cable or flex tube)	Catalog Number	Catalog Description
CTU kit for 1E Chassis	FACT	1 to 4 cables with diameter 5 to 8,5 mm or 1 cable with diameter 8,5 to 15 mm	760243102	FACT-FRACCCTU1E
CTU kit for 2E Chassis	FACT	1 to 4 cables with diameter 5 to 8,5 mm or 1 cable with diameter 8,5 to 15 mm	760243103	FACT-FRACCCTU2E
CTU kit for 3E Chassis	FACT	1 to 4 cables with diameter 5 to 8,5 mm or 1 cable with diameter 8,5 to 15 mm	760243104	FACT-FRACCCTU3E
CTU kit for 4E Chassis	FACT	1 to 4 cables with diameter 5 to 8,5 mm or 1 cable with diameter 8,5 to 15 mm	760243105	FACT-FRACCCTU4E
CTU kit for 5E Chassis	FACT	1 to 4 cables with diameter 5 to 8,5 mm or 1 cable with diameter 8,5 to 15 mm	760243106	FACT-FRACCCTU5E
CTU kit for 6E Chassis	FACT	1 to 4 cables with diameter 5 to 8,5 mm or 1 cable with diameter 8,5 to 15 mm	760243107	FACT-FRACCCTU6E

Note: All FACT-FRACCCTU kits include one side guide channel part per chassis element count and one angled part per kit.

FACT CABLE ATTACHMENT PLATE ORDERING INFORMATION			
Description - Kit content	Compatible with frame	Catalog Number	Catalog Description
One cable attachment plate for frame side duct & One cable to flex conversion component set	FACT	760243108	FACT-FRACCAPL
One cable to flex conversion component set for cable attachment plate	FACT	760243111	FACT-FRACCCTF
One fan out fixation plate for frame side duct & Eight fan out fixation component sets	FACT	760243109	FACT-FRACCFOPL
Eight fan out fixation component sets (for fan out fixation plate)	FACT	760243112	FACT-FRACCFOFK-8

FACT Splice chassis

The FACT splice chassis is a multipurpose splice shelf featuring up to 96 ANT splices or 72 SMOUV splices per FACT element. In combination with the FACT-ACCCTU accessories, the FACT splice chassis supports multiple splice applications, including:

- Outdoor-to-indoor loose-tube cable
- Loose-tube cable to pigtails (single aramid yarn termination)
- Loose-tube cable to breakout or intra-facility (IFC) cable
- Pigtail to pigtail (single aramid yarn termination)



Figure 19: Four-element splice chassis, six trays per element, 12 SMOUVs per tray

FACT SPLICE CHASSIS ORDERING INFORMATION

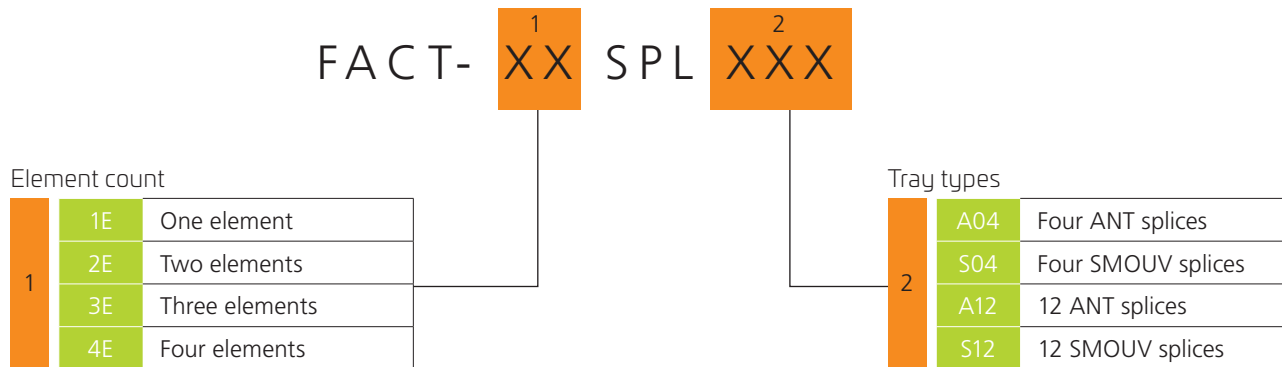

NUMBER OF TRAYS PER FACT-CHASSIS				
	A04	S04	A12	S12
1E	12	12	8	6
2E	24	24	16	12
3E	36	36	24	18
4E	48	48	32	24

Let's shape the future together.

The transition to centralized radio access networks (C-RAN), the increasing use of virtual fiber in support of small cells, the need to migrate to higher lane speeds—trends and technologies like these are reshaping today's central office and driving demand for fiber to levels unimagined just a few years ago. As fiber counts grow, fiber management grows more demanding.

At CommScope, we know exactly what you're up against. We don't just participate in trends—we pioneer them. For over 40 years, we have partnered with our customers to identify, design and build specialized solutions for data centers, headends and central offices.

So relax. With CommScope and solutions like our FACT optical distribution frame (ODF) system, you're set. One modular platform—one innovative and experienced partner to help you evolve and grow your network, unimpeded and with the confidence you need.

For more information on the FACT ODF, **contact CommScope**. Let's shape the future together.



Appendix

FIST-GR3 FRAME ORDERING INFORMATION				
Description	Dimensions: H x W x D	Max. termination capacity	Catalog number	Catalog description
Frame with 2 x 150 mm side ducts	2,200 mm x 900 mm x 300 mm (87 in. x 35 in. x 12 in.)	2,688 LC or 1,344 SC connections per frame	CS6171-000	FIST-GR3-R-150/150-2-22
Frame with 150 mm and 300 mm side duct	2,200 mm x 1,050 mm x 300 mm (87 in. x 41 in. x 12 in.)	2,688 LC or 1,344 SC connections per frame	CS6177-000	FIST-GR3-R-150/300-2-22
Frame with 2 x 300 mm side ducts	2,200 mm x 1,200 mm x 300 mm (87 in. x 47 in. x 12 in.)	2,688 LC or 1,344 SC connections per frame	CS6174-000	FIST-GR3-R-300/300-2-22

All frames include:

- Two side ducts with integrated ETSI mounting profiles: manage and house cables, pigtails, patch cords
- Base duct measures 8HU
- Loose drums (15x)
- Cable attachment plates and drum plates integrated into management panel
- Wall and back-to-back connection kits
- Earthing kit
- Adjustable feet
- Intuitive installation instructions and footprint template
- Rack-painted (powder-coated) light gray (RAL-7035)
- Label kit for color identification of the spools
- All hardware and fasteners

FIST-GR3 FRAME ACCESSORIES ORDERING INFORMATION				
Description	Dimensions	Catalog number	Catalog description	
FACT back plate, mounts four FACT elements in GR3 frame	120 mm x 531.5 mm (H x W) (4.8 in. x 20.9 in.)	760239955	FACT-ACCBPL4E	
FACT back plate, mounts 28 FACT elements in GR3 frame (recommended)	873 mm x 531.5 mm (H x W) (34.4 in. x 20.9 in.)	760239956	FACT-ACCBPL28E	
Door for 150 mm side duct	2,200 mm x 150 mm (H x W) (87 in. x 6 in.)	CZ9821-000	FIST-GR3-D-150-22-2	
Door for 300 mm side duct	2,200 mm x 300 mm (H x W) (87 in. x 12 in.)	CZ9825-000	FIST-GR3-D-300-22-2	
Door for 600 mm side duct, w/lock	2,200 mm x 600 mm (H x W) (87 in. x 24 in.)	CZ9827-000	FIST-GR3-D-600-22-2	
Top cover for 150 mm side duct	150 mm x 300 mm (W x D) (6 in. x 12 in.)	CZ9047-000	FIST-GR3-T-150	
Top cover for 300 mm side duct	300 mm x 300 mm (W x D) (12 in. x 12 in.)	CW5887-000	FIST-GR3-T-300	
Top cover for 600 mm central section	600 mm x 300 mm (W x D) (24 in. x 12 in.)	CK8631-000	FIST-GR3-T-600	
Set (of two) side or back panels	2,200 mm x 300 mm (H x W) (87 in. x 12 in.)	CS9084-000	FIST-GR3-P-300-22	
Storage bay (includes a fiber passage for back-to-back configuration)	2,200 mm x 300 mm x 300 mm (H x W x D) (87 in. x 12 in. x 12 in.)	CV7092-000	FIST-GR3-SB-300-22-2	
Extended base duct for 150 mm side duct; increases patch cord capacity at bottom of frame; incoming feeder cable must come from top of frame	215 mm (D) (8.5 in.)	EF7794-000	FIST-GR3-BD-150/215	
Extended base duct for 300 mm side duct; increases patch cord capacity at bottom of frame; incoming feeder cable must come from top of frame	215 mm (D) (8.5 in.)	EF7793-000	FIST-GR3-BD-300/215	
Set (of two) side-by-side brackets	n/a	CC9465-000	FIST-GR3-ST5	
Kit to route jumpers from front to back of rack; required when using extended base duct	215 mm (D) (8.5 in.)	EF8196-000	FIST-GR3-BD-BTB-600/215	
Containment brackets—maintain patch cords in side duct	n/a	315826-000	FIST-GR2-PCBR-10	

Appendix

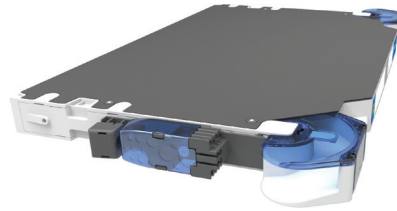

Figure 17: Cable termination unit (CTU) on chassis

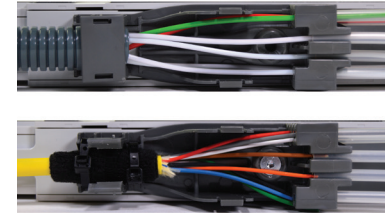

Figure 18: Installed cable termination units (CTUs) on FACT chassis

FACT CABLE TERMINATION UNIT (CTU) ORDERING INFORMATION

Cable type—termination capacity	Compatible Frame Type(s).	Diameter range	Catalog number	Catalog description
CTU for one cable with maximum diameter of 15 mm (.6 in.) or one flex tube of 12-16 mm (.5 in.–.6 in.) (with transparent cover)	FACT and FIST-GR3	Cable: 9 mm to 15 mm (.4 in. to .6 in.) Flex tube: 1 x ID 12 mm, or 2 x ID 10 mm (1 x ID .5 in., or 2 x ID .4 in.)	760239897	FACT-ACCCTULLT
CTU for one cable with maximum diameter of 15 mm (.6 in.) or one flex tube of 12-16 mm (.5 in.–.6 in.)	FACT and FIST-GR3	Cable: 9 mm to 15 mm (.4 in. to .6 in.) Flex tube: 1 x ID 12 mm, or 2 x ID 10 mm (1 x ID .5 in., or 2 x ID .4 in.)	760239898	FACT-ACCCTUMLT
One IFC-cable	FACT and FIST-GR3	15 mm (max.) (.6 in. max.)	760239899	FACT-ACCCTUMIFC
Trumpet, KTUs for 24 pigtails	FACT and FIST-GR3	1.8 mm (min.) 2.4 mm (max.) (.07 in. min.) (.09 in. max)	760239900	FACT-ACCCTUMP24
One or two IFC-cables	FACT and FIST-GR3	One cable: 8.5 mm (max.) (.3 in. max.) Two cables: 6 mm (max.) (.2 in. max.)	760239951	FACT-ACCCTUSIFC
One fiber cable or one flex tube 6/10 mm	FACT and FIST-GR3	Cable: 8.5 mm (fiber cable max.) (.3 in. fiber cable max.) Flex tube: 1 x 10 mm (1 x .4 in.)	760239952	FACT-ACCCTUSLT

FIST-GR3 CABLE ATTACHMENT PLATE ORDERING INFORMATION

Description	Catalog number	Catalog description
L-cable attachment plate—supports up to 10 IFC or breakout cables; mounts perpendicularly in side duct	EG5792-000	FIST-GR3-BOIC-LPL
Back plate for 300 mm (11.8 in.) duct—accommodates up to nine FIST-GR2-BOIC-LPL; mounts flat on 300 mm (11.8 in.) side duct	D35100-000	FIST-GR2-BOIC-BPL
Internal extension cable attachment plate for 150 mm (5.9 in.) side duct	CW8226-000	FIST-GR3-CAP-150-INT
Internal extension cable attachment plate for 300 mm (11.8 in.) side duct	EG0850-000	FIST-GR3-CAP-300-INT
Containment brackets; manage patch cords in side duct	315826-000	FIST-GR2-PCBR-10

CommScope pushes the boundaries of communications technology with game-changing ideas and ground-breaking discoveries that spark profound human achievement.

We collaborate with our customers and partners to design, create and build the world's most advanced networks. It is our passion and commitment to identify the next opportunity and realize a better tomorrow. Discover more at commscope.com

COMMSCOPE®

commscope.com

Visit our website or contact your local CommScope representative for more information.

© 2019 CommScope, Inc. All rights reserved.

Unless otherwise noted, all trademarks identified by ® or ™ are registered trademarks, respectively, of CommScope, Inc. This document is for planning purposes only and is not intended to modify or supplement any specifications or warranties relating to CommScope products or services. CommScope is committed to the highest standards of business integrity and environmental sustainability with a number of CommScope's facilities across the globe certified in accordance with international standards, including ISO 9001, TL 9000, and ISO 14001.

Further information regarding CommScope's commitment can be found at www.commscope.com/About-Us/Corporate-Responsibility-and-Sustainability.

BR-1107369-EN (09/19)